

**COBRHA XSD
Version 1.7**

This document is provided to you free of charge by the

eHealth platform
Willebroekkaai 38 – 1000 Brussel
38, Quai de Willebroeck – 1000 Bruxelles

All are free to circulate this document with reference to the URL source.

Table of contents

Table of contents	2
1 Document management	3
1.1 Document history	3
1.2 Publication Input Data (ehealth-cobrha-schema-core.xsd)	3
1.2.1 Common Data Model Structure	3
1.2.2 Used Types	15
1.2.3 Business Types	15
1.3 Request Report (ehealth-cobrha-schema-report.xsd)	44
1.3.1 Request Report Structure	45
1.3.2 Used Types	46
1.4 Meta Data XML File	50
1.4.1 Meta Data file XML Structure (ehealth-zipmetadata.xsd)	50
1.5 Synchronous Publish Operation Web Service	51
1.5.1 PublishRequest XML Structure (ehealth-cobrha-publication-schema-protocol.xsd).....	51
1.5.2 PublishResponse XML Structure (ehealth-cobrha-publication-schema-protocol.xsd)	52



1 Document management

1.1 Document history

Version	Date	Author	Description of changes / remarks
1.0	21/05/2014	eHealth platform	Initial version
1.1	07/07/2015	eHealth platform	Add SpecialityID in SpecialityApproval Add restriction for Date
1.7	19/06/2017	eHealth platform	<ul style="list-style-type: none">• CBE: add a new element contact type• HCOrganization: new element CBESCompany• HCProfessional: new element Subscription that contains the subscriptionNumber and a new element SubscriptionPeriod• Address : the element Type (deprecated) is replaced by element AddressType• Contact: the element ContactType (deprecated) is replaced by element CommunicationType
1.8	04/07/2018	eHealth platform	Update

1.2 Publication Input Data (ehealth-cobrha-schema-core.xsd)

The xsd is the same for publication or consultation by file exchange (batch) or web service.

Remark:

For a publication, you can only publish one operation element with the web service instead of multiple operation elements in file exchange.

For a consultation, you can only get Max 1operation element in the response instead of limitless operation elements by file exchange.

For a publication using file exchange, the Max operations is 10.000.

1.2.1 Common Data Model Structure

The schema described below is the one that has to be used at the creation of the update of an actor. This structure corresponds to the one described in the consultation cookbook.



1.2.1.1 Common Data Model root: Five Operation Elements

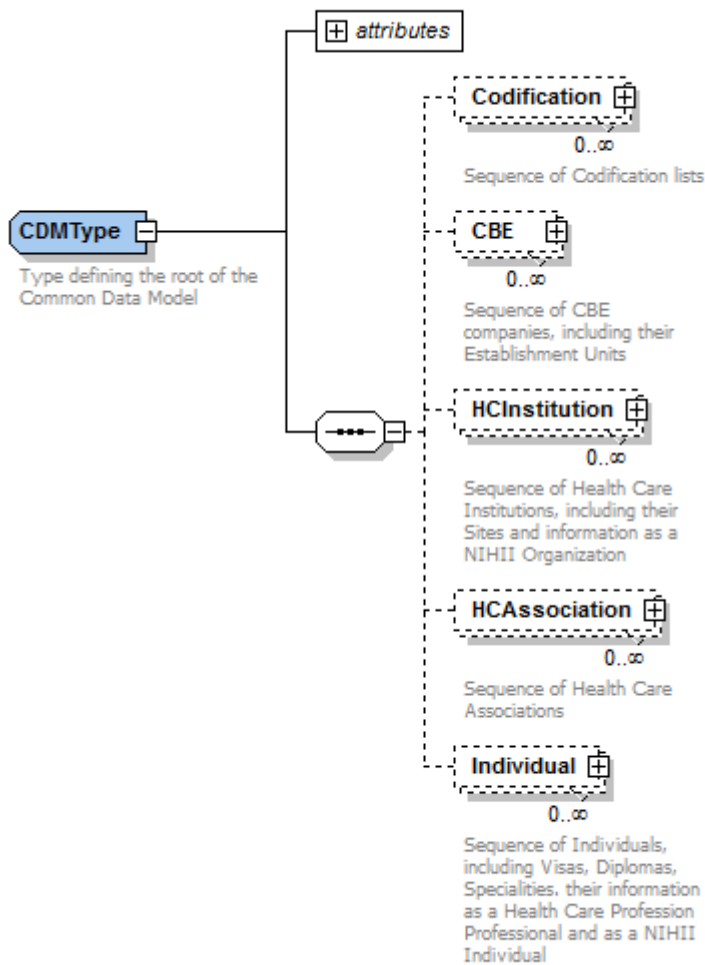

Field name	Description
Codification	This operation type allows you to publish a codification, used in in other operation elements. See CodificationType for detailed description (section 1.2.1.2.2).
CBE	This operation type allows you to publish CBE enterprise units and CBE establishment units. See CBEType for detailed description (section 1.2.1.2.3). Remark: this operation is only used by authentic source CBE
HCInstitution	This operation type allows you to publish a healthcare Institution as a hospital, pharmacy, rest home, See HCInstitutionType for detailed description (section 1.2.1.2.1).

HcAssociation	This operation type allows you to publish a healthcare association (ex. SMUR Association) that has a unique identifier. It can be composed of multiple healthcare institutions and/or associations. See HcAssociationType for detailed description (section 1.2.1.2.4).
Individual	This operation type allows you to publish an individual identified by his INSS code and the important healthcare related data linked to him. See IndividualType for detailed description (section 1.2.1.2.5).

Attribute OperationID:

In every element linked to the root, the attribute OperationID must be present. This OperationID is an unsigned integer and identifies uniquely all operations linked to the cdm root. It is a technical id in order to identify the operations when reporting. We advise to use an auto increment value for it. Best practice: first element linked to the root has id with value 1, second has id with value 2, etc. You can find an example with the use of operationId in annex.

Other attributes:

Each element in the xsd has an optional startDate, endDate, InvalidElement.

StartDate: beginning of the validity of the element (type: date -> YYYY-MM-DD). StartDate must be ≥ 1200-01-01

EndDate: end of the validity of the element (type: date -> YYYY-MM-DD). EndDate must be ≥ 1200-01-01

InvalidElement: indication if the element is valid or not (type: boolean)



1.2.1.2 Operations

1.2.1.2.1 HCInstitutionType

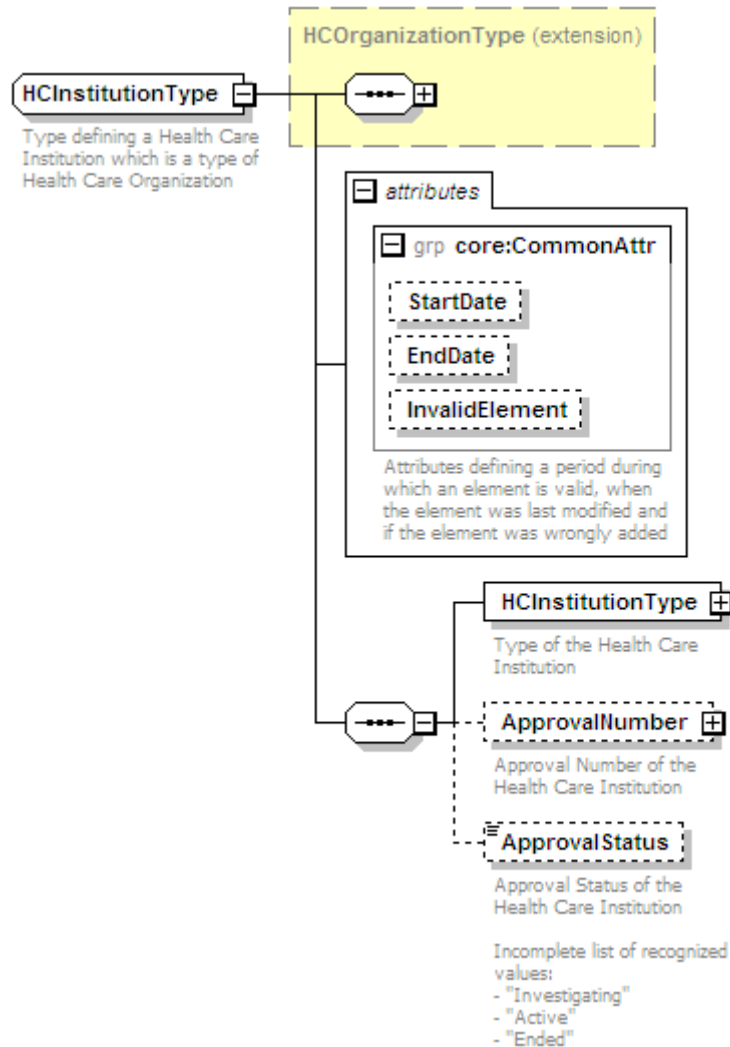

Field name	Description
extension HCOrganizationType (mandatory)	All general data about the healthcare organization (global details of the healthcare institution) is encapsulated within. See used types: HCOrganizationType for more details (section 1.2.3.1.1).
HCInstitutionType – CodeWithDescriptionType (mandatory for creation)(optional for delta)	Type of the healthcare institution. Example: NIHII gives code 710 for hospitals. Type of the code is 'hcinstitution type'. See used types: CodeWithDescriptionType for more details (section 1.2.3.5).
ApprovalNumber – IdentifierType (optional)	The approval number of the institution. (erkeningsnummer, numéro d'agrément) Authentic source: 'WVG_VAZG', 'WVG_KG' (kind en gezin), 'WVG_JW' (jongeren en welzijn), 'WVG_VAPH', FAGG Type: 'approval number'. See used types: IdentifierType for more details (section 1.2.3.6).

ApprovalStatus – CodeWithDescriptionType (mandatory)

The approval status of the institution. Accepted values for types: 'Investigating', 'Active', 'Ended'. Authentic source: 'WVG_VAZG', 'WVG_KG' (kind en gezin), 'WVG_JW' (jongeren en welzijn), 'WVG_VAPH', FAGG, SPW. Type is 'institution approval status'. See used types: CodeWithDescriptionType for more details (section 1.2.3.5).

1.2.1.2.2 CodificationType element

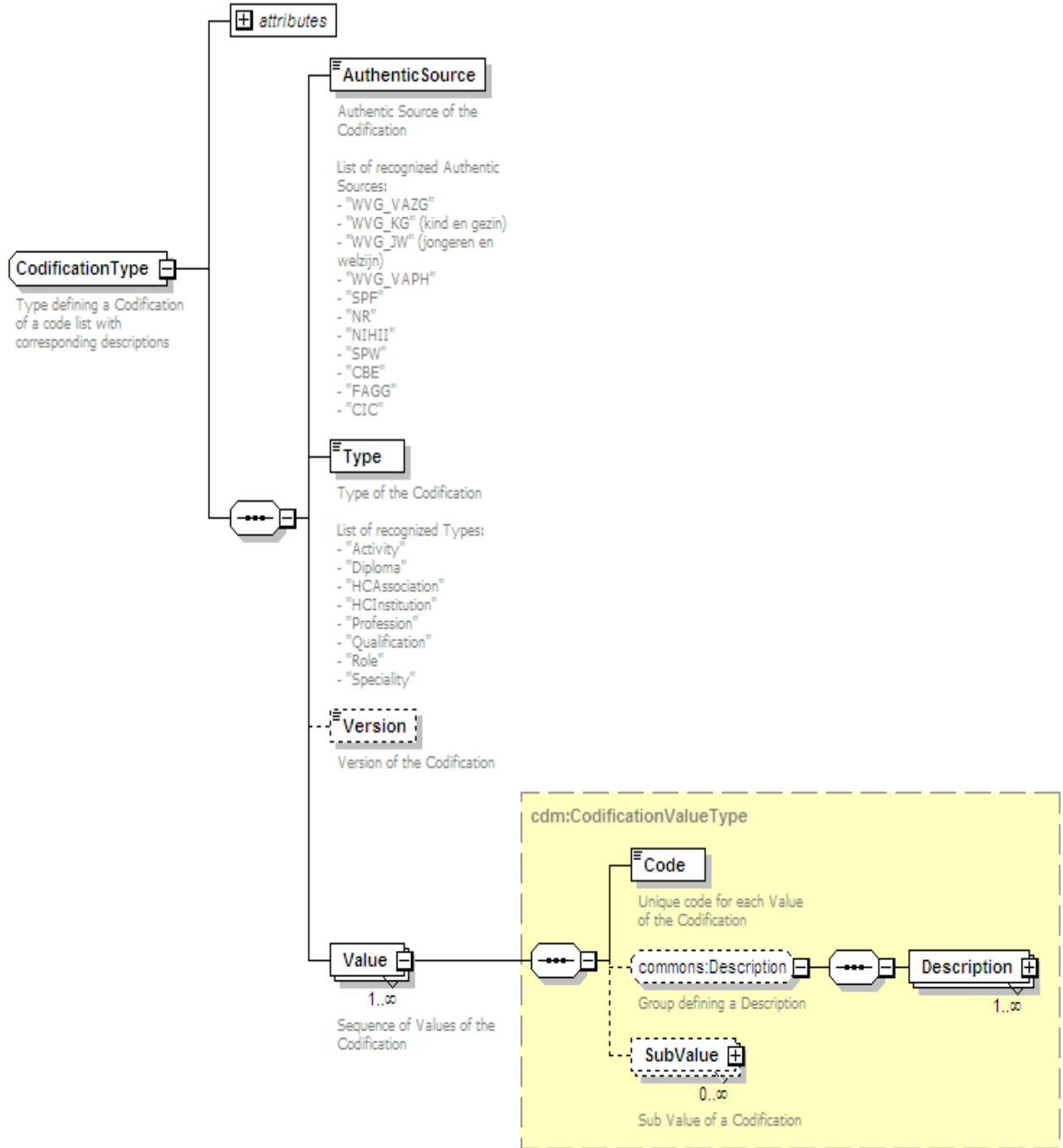

Generated by XMLSpy

www.altova.com



Field name	Description
AuthenticSource (mandatory)	Authentic source of the codification. The value is a string of Max 30 Char encoded in UTF-8. Accepted values for authentic sources: 'WVG_VAZG', 'WVG_KG' (kind en gezin), 'WVG_JW'(jongeren en welzijn), 'WVG_VAPH', 'WVG_WS' (Welzijn en Samenleving) 'NR', 'CBSS', 'NIHII', 'AVIQ', 'CBE', 'FAMHP', 'BeSt', 'FPS_PH', 'NIS', 'CRAB', 'BePost', 'ISO' 'CCC_GGC' (Cocom), 'GSC_DG' (Dutch Speaking Community), 'OV_AgODi' (Onderwijs en Vorming)
Type (mandatory)	Identifies uniquely on which CodeWithValueType element the code applies. The value is a string of Max 240 Char encoded in UTF-8 and has the same name as the type names described in the CodeWithDescriptionType elements. (Examples: 'activity type', 'diploma type', 'hcinstitution type', 'profession type', 'qualification type', 'role type', 'speciality type', 'STA', 'ZIP', 'ISO-...', 'site approval status', 'activity approval status', 'institution approval status', street, house number, post box, municipality, country, address)
Version (optional)	Describes the version of the codification. When you use a version for a codification, you need to specify the same version value in case of update and a new version value to create a new codification. The value is a string of Max 240 Char encoded in UTF-8.
Value (mandatory)	Code value of the codification with description and sub codes. See below for the detailed details rmaton
Value: Code (mandatory)	Unique value of the code: a string of Max 30 Char encoded in UTF-8.
Value: SubValue (optional)	Code values linked to the parent code value given in the parent Value:Code tag. See used types: CodificationType (section 1.2.1.2.2)
Value: Description (optional)	The description of the code value. See used types: DescriptionGroup for more details (section 1.2.3.12).

1.2.1.2.3 CBEType element

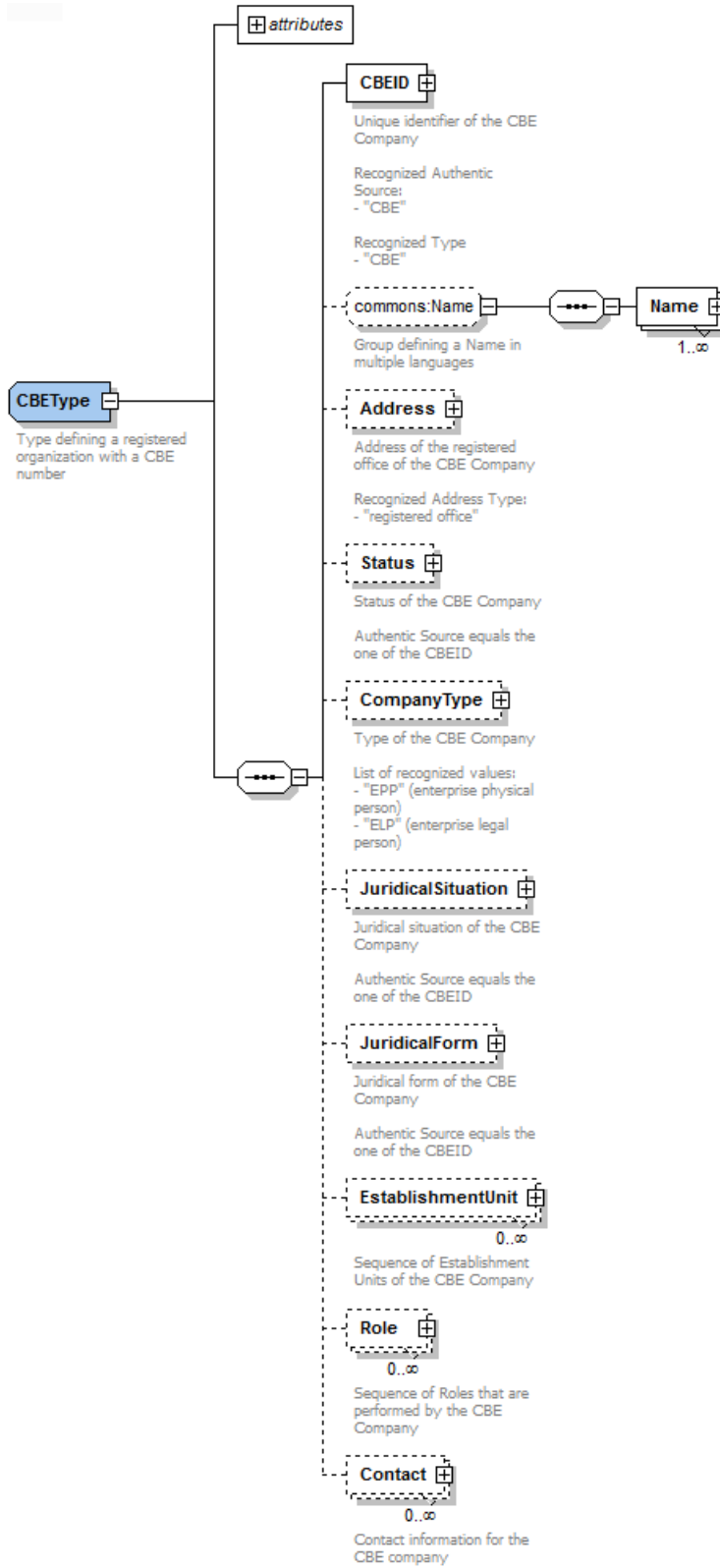

Field name	Description
CBEID – IdentifierType (mandatory)	Unique identifier of an enterprise provided by the CBE. The authentic source is thus the CBE, the type is “CBE” and the identifier is a structured string. See used types: IdentifierType for more details (section 1.2.3.6).
Name (optional)	Name of the enterprise. The value is a string of Max 2000 Char encoded in UTF-8.
Address – AddressType (optional)	Address of the registered office of the enterprise. The type of the address is thus ‘registered office’. See used types: AddressType for more details (section 1.2.3.3).
Status – CodeWithDescriptionType (optional)	Current state of the BCE enterprise (actif,cancelled,stopped,...). The code is a string. The type is ‘STA’. See used types: CodeWithDescriptionType for more details (section 1.2.3.5).
CompanyType – CodeWithDescriptionType (optional)	Type of the CBE enterprise. The code is a string. The type is ‘comptyp’ Two string values are actually possible ‘EPP’ (enterprise physical person) or ‘ELP’ (enterprise legal person). See used types: CodeWithDescriptionType for more details (section 1.2.3.5).
JuridicalSituation – CodeWithDescriptionType (optional)	The juridical situation of the enterprise. The type is ‘jursit’. The code is a string. See used types: CodeWithDescriptionType for more details (section 1.2.3.5).
JuridicalForm – CodeWithDescriptionType (optional)	Current juridical form of the enterprise. The type is ‘jurform’. The code is a string. See used types: CodeWithDescriptionType for more details (section 1.2.3.5).
EstablishmentUnit – EstablishmentUnitType (optional)	Establishment unit of the enterprise. See used types: EstablishmentUnitType for more details (section 1.2.3.1.5).
Role – RoleType (optional)	Role performed by the establishment unit. See used types: RoleType for more details (section 1.2.3.1.4).
Contact - ContactType	Contact details of the enterprise. See used types: ContactType for more details (section 1.2.3.10).

1.2.1.2.4 HCAssociationType element

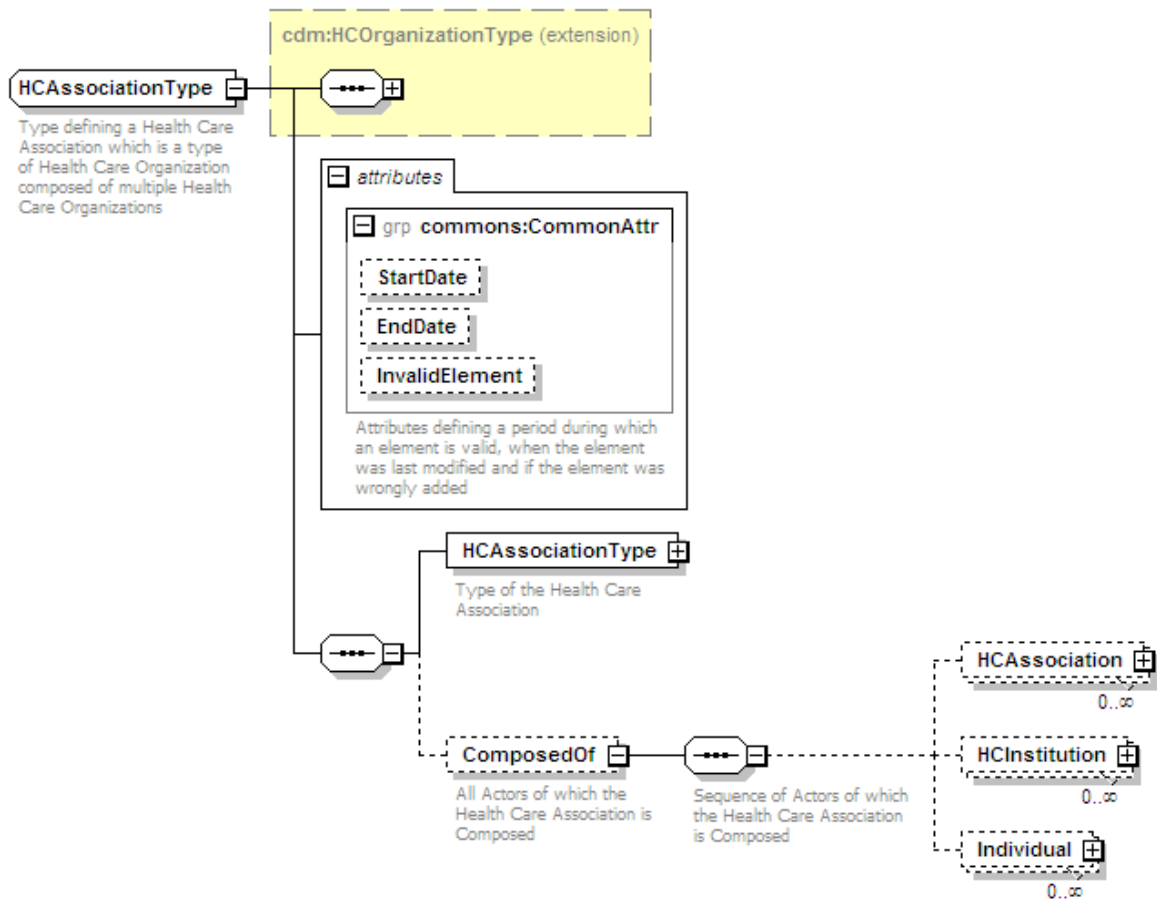

Field name	Description
Extension HCOrganizationType (mandatory)	All general data about the healthcare organization that represents the healthcare association, is encapsulated within. See used types: HCOrganizationType for more details (section 1.2.3.1.1).
HCAssociationType – CodeWithDescriptionType (mandatory for creation)(optional for delta)	Code value of the type of the healthcare association. The type is 'hcaassociation type'. See used types: CodeWithDescriptionType for more details (section 1.2.3.5).
ComposedOf (optional)	ComposedOf gives the list of healthcare actors that compose the association. Can be another HCAssociation or HCInstitution or Individual. See operations: HCAssociation, HCInstitution for more details See used types: IndividualType for more details (section 1.2.1.2.5).

1.2.1.2.5 IndividualType element

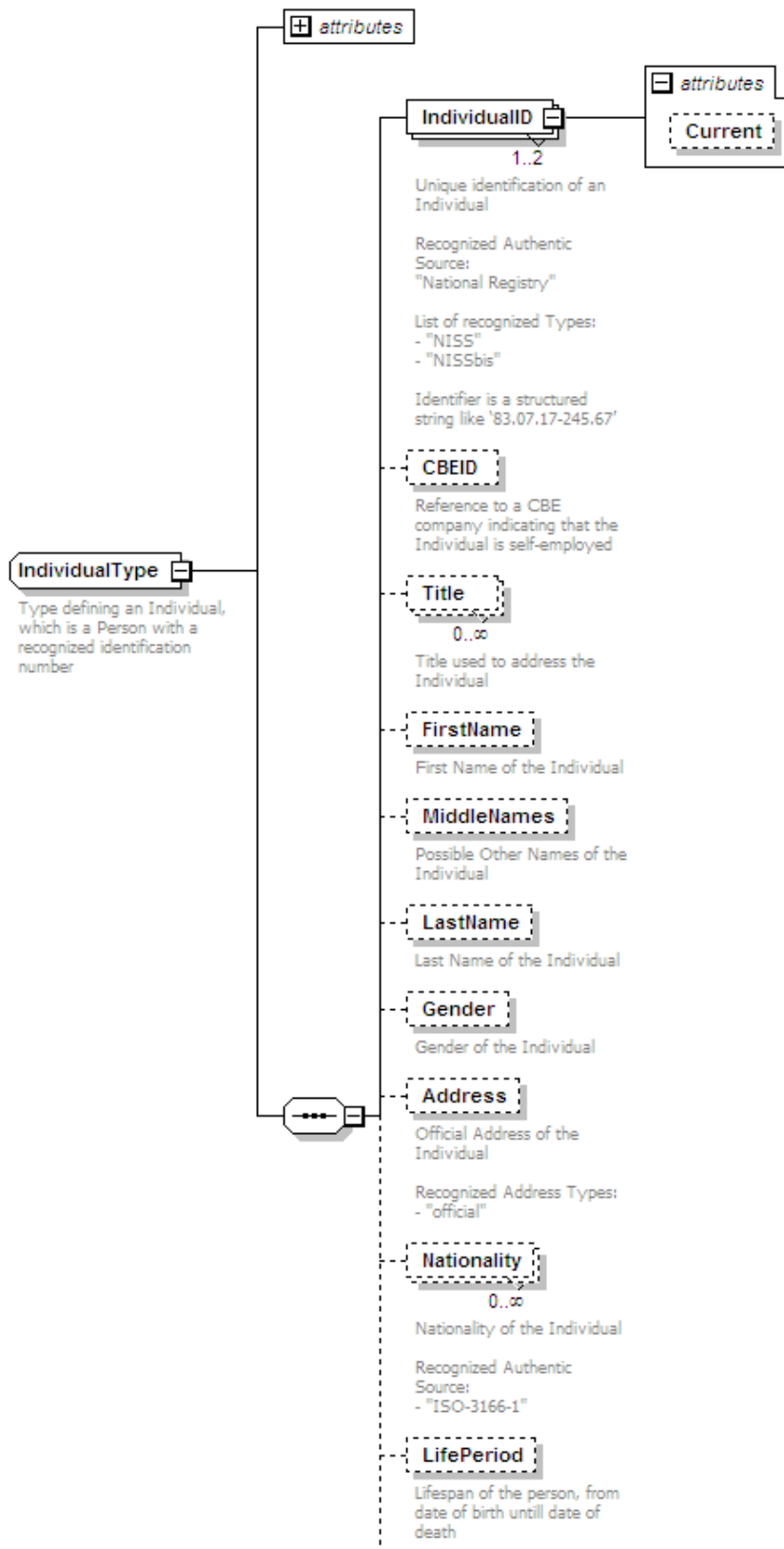

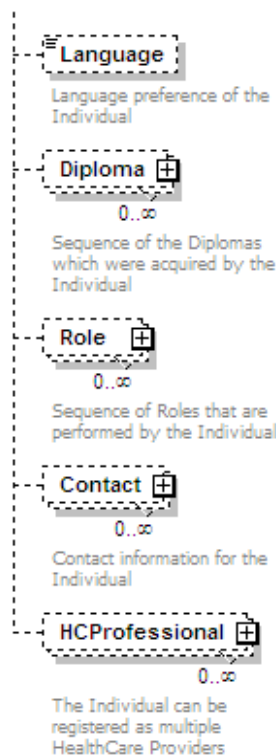

Field name	Description
IndividualID – IdentifierType (mandatory)	Unique identifier of the individual provided by the 'NR'. Two types are possible: 'NISS' or 'NISSbis' (rijksregister nummer, numéro du registre national). The authentic source is thus the 'NR', the type is 'NISS or NISSbis' and the identifier is a structured string like '83071724567'. See used types: IdentifierType for more details (section 1.2.3.6). There will also be an attribute 'Current' when two IndividualID exist. This attribute (boolean value) indicates which of the two ID is the current one.
CBEID – IdentifierType (optional)	If the individual is employed by his own enterprise, the enterprise number from the CBE (KBO) that uniquely identifies the enterprise should be entered in this tag. Authentic source: 'CBE', type: 'CBE'. See used types: IdentifierType for more details (section 1.2.3.6).
Title – LocalizedString (optional)	Title to address the individual with the language of the title as attribute. See used types: LocalizedString for more details (section 5.6.4.5).
FirstName – string (optional)	First name of the individual if available (Max Char: 240 + utf-8).
MiddleNames – string (optional)	Middle names of the individual if available (Max Char: 240 + utf-8).
LastName – string (mandatory for creation)(optional for delta)	Last name of the individual (Max Char: 240 + utf-8).
Gender – enum (optional)	Gender (sex) of the individual. Only following values are possible: not known, male, female, not applicable.

Address – AddressType (optional)	Official address of the individual. He can only have one official address. The type of the address is thus 'official'. See used types: AddressType for more details (section 1.2.3.3).
Nationality – CodeWithDescriptionType (optional)	Nationality/ies of the individual provided by the 'NR'. The code is a string (example: BE for Belgium nationality). The Authentic Source is 'NIS' and type is 'country'. Optionally the name of the nation with the language linked to, can be given in the DescriptionGroup. See used types: CodeWithDescriptionType for more details (section 1.2.3.5).
LifePeriod – PeriodType (optional)	Date of birth and death date of the individual if available. If known, the birth date is mandatory. The birth date is a standard date type (YYYY-MM-DD) element. See used types: PeriodType for more details (section 1.2.3.8).
Language – CodeWithDescriptionType (optional)	Preferred language of the individual in a two-character string following the standard ISO-639-1. Therefore, Authentic Source is ISO and type code ISO-639-1. Examples: NL, FR, DE, EN (XX if unknown) (lowercase or uppercase are accepted). See used types: CodeWithDescriptionType for more details (section 1.2.3.5).
Diploma – DiplomaType (optional)	Diploma of the individual. See used types: DiplomaType for more details (section 1.2.3.1.11).
Activity – ActivityType (optional)	Activity performed by the individual. See used types: ActivityType for more details (section 1.2.3.1.2).
Role – RoleType (optional)	Role performed by the individual. See used types: RoleType for more details (section 1.2.3.1.4).
Contact – ContactType (optional)	Contact details of the individual: e.g. his e-mail. See used types: ContactType for more details (section 1.2.3.10).
HCPProfessional – HCPProfessionalType (optional)	Healthcare profession of the individual. Can be more than one and is given by the authentic source 'FPS_PH'. See used types: HCPProfessionalType for more details (section 1.2.3.1.8).

1.2.2 Used Types

Two types exist: business and technical types. The business types are concrete elements that represent a well-defined business entity like a site, establishment unit, role ... Technical types are complex xml elements frequently used in business types like addresses, codes, localized descriptions, ...

The schema of the business types: see ehealth-cobrha-schema-core.xsd.

The schema of the technical types see ehealth-cobrha-schema-commons.xsd.

1.2.3 Business Types

1.2.3.1.1 HCOrganizationType

See next page



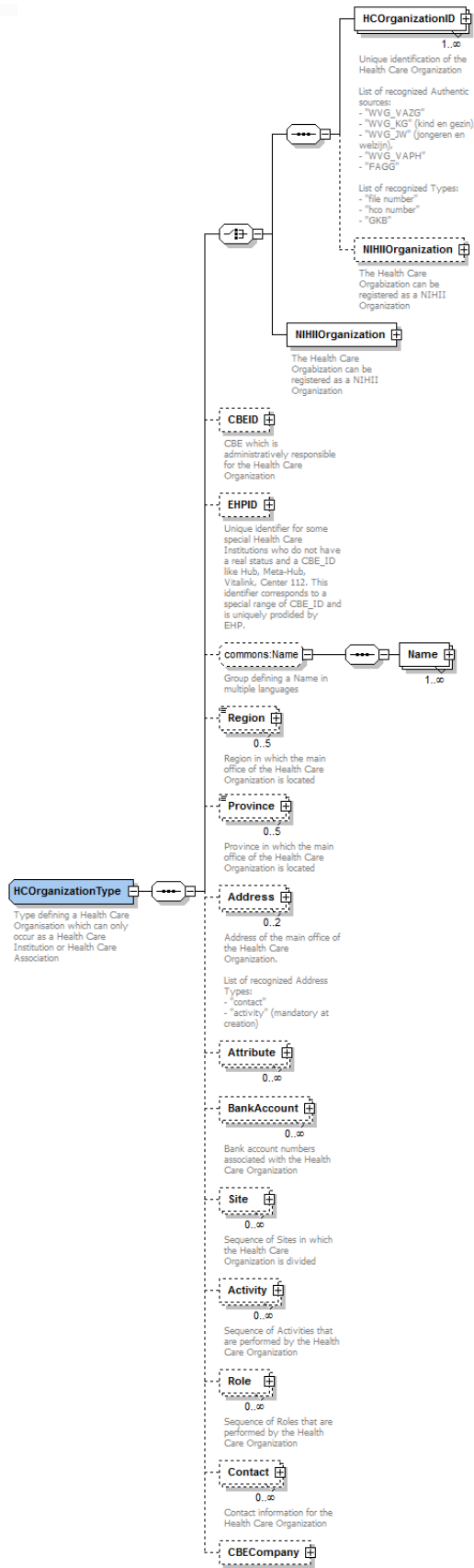

Field name	Description
HCOrganizationID – IdentifierType (mandatory if chosen for)	Unique identifier of the healthcare organization. Possible authentic sources: 'WVG_VAZG', 'WVG_KG'(kind en gezin), 'WVG_JW'(jongeren en welzijn), 'WVG_VAPH', 'WVG_WS' (Welzijn en Samenleving), 'NR', CBSS', 'NIHII', 'AVIQ', 'CBE', 'FAMHP', 'BeSt', 'FPS_PH', 'NIS', 'CRAB', 'BePost', 'ISO' 'CCC_GGC' (Cocom), 'GSC_DG' (Dutch Speaking Community), 'OV_AgODi' (Onderwijs en Vorming), 'EHP'. See used types: IdentifierType for more details (section 1.2.3.6).
NIHIIOrganization – NIHIIOrganizationType (mandatory if chosen for)	All required data extracted from NIHII, if the healthcare organization is registered as a NIHII organization. See used types: NIHIIOrganizationType for more details (section 1.2.3.1.6).
CBEID – IdentifierType (deprecated)	Unique identifier of the enterprise that is administratively responsible of the healthcare institution provided by the CBE. The authentic source is thus the CBE, the type is 'CBE' and the identifier is a structured string. See used types: IdentifierType for more details (section 1.2.3.6).
Name (mandatory)	Name of the healthcare institution. The value is a string of Max 2000 Char encoded in UTF-8.
Region – LocalizedString (optional)	Name of the region where the main office of the healthcare organization is located. The language of the name must be set as an attribute. Examples: Vlaamse Gemeenschap (Dutch), Region Wallonne (French). See used types: LocalizedString for more details (section 1.2.3.7).
Province – LocalizedString (optional)	Province where the main office of the healthcare organization is located. The language of the name must be set as an attribute. Examples: Luxembourg (French), Oost-Vlaanderen (Dutch). See used types: LocalizedString for more details (section 1.2.3.7).
Address – AddressType (optional)	Current contact/activity address of the healthcare organization. The type of the address is thus 'contact' or 'activity'. Activity address is mandatory at creation. See used types: AddressType for more details (section 1.2.3.3).
BankAccount – BankAccountType (optional)	Bank account linked to the healthcare organization. See used types: BankAccountType for more details (section 1.2.3.4).
Site – SiteType (optional)	Site linked to the healthcare organization. See used types: SiteType for more details (section 1.2.3.1.3).
Activity – ActivityType (optional)	Activity performed by the healthcare organization. See used types: ActivityType for more details (section 1.2.3.1.2).
Role – RoleType (optional)	Role performed by a healthcare organisation. See used types: RoleType for more details (section 1.2.3.1.4).
Contact – ContactType (optional)	Contact for the healthcare organization. E.g.an e-mail of the contact person for the organization. See used types: ContactType for more details (section 1.2.3.10).
CBECompany	Enterprise linked to HCIInstitution See used types: CBEType for more details (section 1.2.1.2.3).

1.2.3.1.2 ActivityType

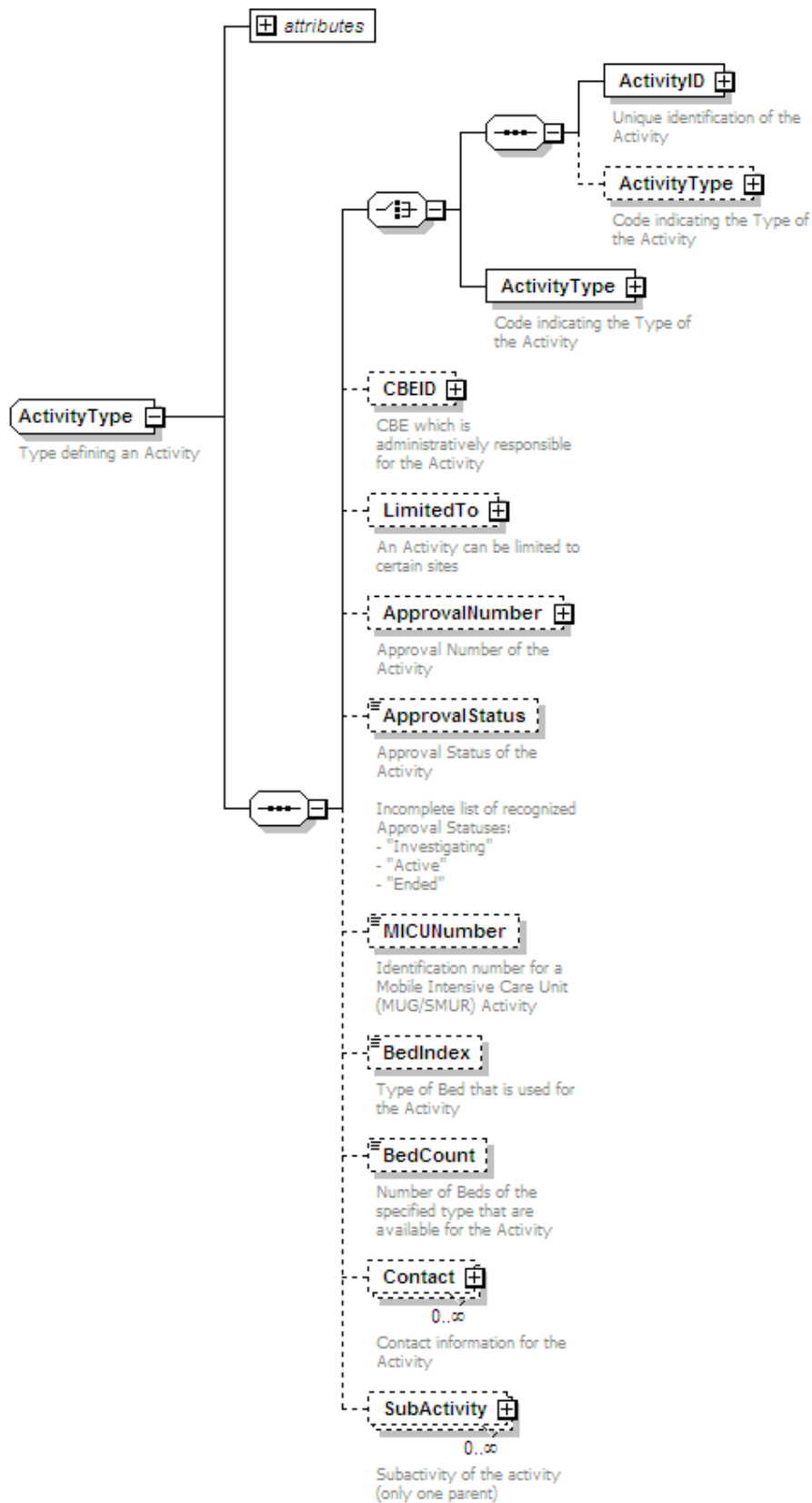

Field name	Description
------------	-------------



ActivityID - IdentifierType (optional)	Unique identifier of the activity. Authentic source: 'WVG_VAZG', 'WVG_KG' (kind en gezin), 'WVG_JW' (jongeren en welzijn), 'WVG_VAPH', 'WVG_WS' (Welzijn en Samenleving), 'NR', 'CBSS', 'NIHII', 'AVIQ', 'CBE', 'FAMHP', 'BeSt', 'FPS_PH', 'NIS', 'CRAB', 'BePost', 'ISO' 'CCC_GGC' (Cocom), 'GSC_DG' (Dutch Speaking Community), 'OV_AgODi' (Onderwijs en Vorming); Type: 'GKB'(deprecated), 'activity number' See used types: IdentifierType for more details (section 1.2.3.6).
ActivityType – CodeWithDescriptionType (mandatory if no ActivityID)	Code indicating the type of the activity. The type is 'activity type'. See used types: CodeWithDescriptionType for more details (section 1.2.3.5).
CBEID – IdentifierType (optional)	If the activity is linked to an enterprise, the CBE number that uniquely identifies the enterprise should be entered in this tag. Authentic source: 'CBE', type: 'CBE'. See used types: IdentifierType for more details (section 1.2.3.6).
LimitedTo – SiteType (optional)	Sites the activity is limited to (e.g.: the SMUR activity is linked to some but not all sites of the healthcare organizations that collaborate in the SMUR activity). See used types: SiteType for more details (section 1.2.3.1.3).
ApprovalNumber – IdentifierType (optional)	Approval number for the activity. Authentic source: 'WVG_VAZG', 'WVG_KG' (Kind en Gezin), 'WVG_JW' (Jongeren en Welzijn), 'WVG_VAPH', FAGG Type: 'approval number'. See used types: IdentifierType for more details (section 1.2.3.6).
ApprovalStatus – CodeWithDescriptionType (optional)	Approval status of the activity. Accepted values for types: 'Investigating', 'Active', 'Ended'. See used types: Authentic source: 'WVG_VAZG', 'WVG_KG' (Kind en Gezin), 'WVG_JW' (Jongeren en Welzijn), 'WVG_VAPH', FAGG, and SPW. The type is 'activity approval status'. See CodeWithDescriptionType for more details (section 1.2.3.5).
MICUNumber – string (optional)	Identification number for a mobile intensive care unit (SMUR/MUG). In fact, it is the chassis number of the vehicle.
BedIndex – string (optional)	Type of bed used for this activity.
BedCount – number (optional)	Available number of beds of the type as specified in the BedIndex for this activity
Contact – ContactType (optional)	Contact for the activity. E.g.an e-mail of the contact person for the activity. See used types: ContactType for more details (section 1.2.3.10).
SubActivity – ActivityType (optional)	Sub-activity linked to the activity. See used types: ActivityType for more details (section 1.2.3.1.2).

1.2.3.1.3 SiteType

See next page



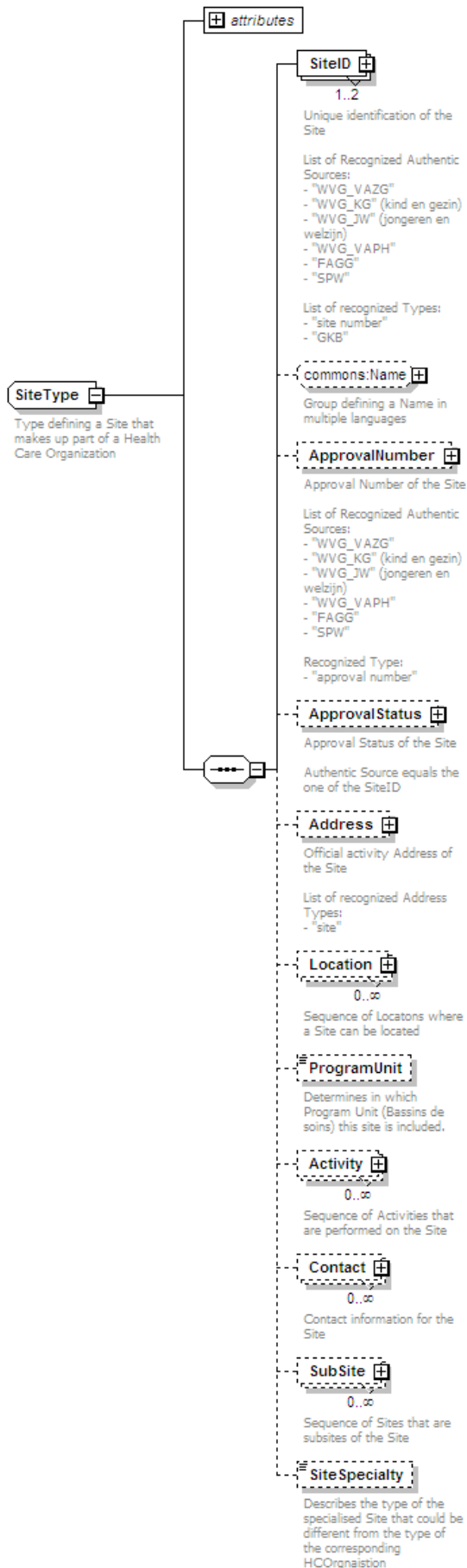

Field name	Description
SiteID – IdentifierType (mandatory)	Unique identifier of the site (example: authentic source: 'WVG_VAZG', 'WVG_KG' (kind en gezin), 'WVG_JW' (jongeren en welzijn), 'WVG_VAPH', 'WVG_WS' (Welzijn en Samenleving), 'NR', CBSS', 'NIHII', 'AVIQ', 'CBE', 'FAMHP', 'BeSt', 'FPS_PH', 'NIS', 'CRAB', 'BePost', 'ISO' 'CCC_GGC' (Cocom), 'GSC_DG' (Dutch Speaking Community), 'OV_AgODi' (Onderwijs en Vorming) Type: 'site number', 'GKB' See used types: IdentifierType for more details (section 1.2.3.6).
Name – NameGroup (optional)	Name and/or abbreviation used for the site, in a specific language.
ApprovalNumber – IdentifierType (optional)	The approval number for the site. Authentic source: 'WVG_VAZG', 'WVG_KG' (kind en gezin), 'WVG_JW' (jongeren en welzijn), 'WVG_VAPH', 'WVG_WS' (Welzijn en Samenleving), 'NR', CBSS', 'NIHII', 'AVIQ', 'CBE', 'FAMHP', 'BeSt', 'FPS_PH', 'NIS', 'CRAB', 'BePost', 'ISO' 'CCC_GGC' (Cocom), 'GSC_DG' (Dutch Speaking Community), 'OV_AgODi' (Onderwijs en Vorming) Type: 'approval number', SPW. See used types: IdentifierType for more details (section 1.2.3.6).
ApprovalStatus – CodeWithDescriptionType (optional)	Approval status of the site, of the type 'site approval status'. Accepted values for types: 'Investigating', 'Active', 'Ended'. Authentic source: 'EHP'. See used types: CodeWithDescriptionType for more details (section 1.2.3.5).
Address – AddressType (optional)	Address of the site, of the type 'site'.
Location – LocationType (optional)	Location of the site. See used types: LocationType for more details (section 1.2.3.1.7).
Activity – ActivityType	Activities performed on the site. See used types: ActivityType for more details (section 1.2.3.1.2).
Contact – ContactType (optional)	Contact for the site. E.g. an e-mail of a person from the secretariat of the site. See used types: ContactType for more details (section 1.2.3.10).
SubSite – SiteType (optional)	A sub site that is part of the site. See used types: SiteType for more details (section 1.2.3.1.3).
SiteSpeciality – string (optional)	Organizational type of the specialized site that could be different from the organizational type of the corresponding healthcare Organization. If available, this type gives a more precise definition of the site's purpose. (Max Char 240 + utf-8 encoded).

1.2.3.1.4 RoleType

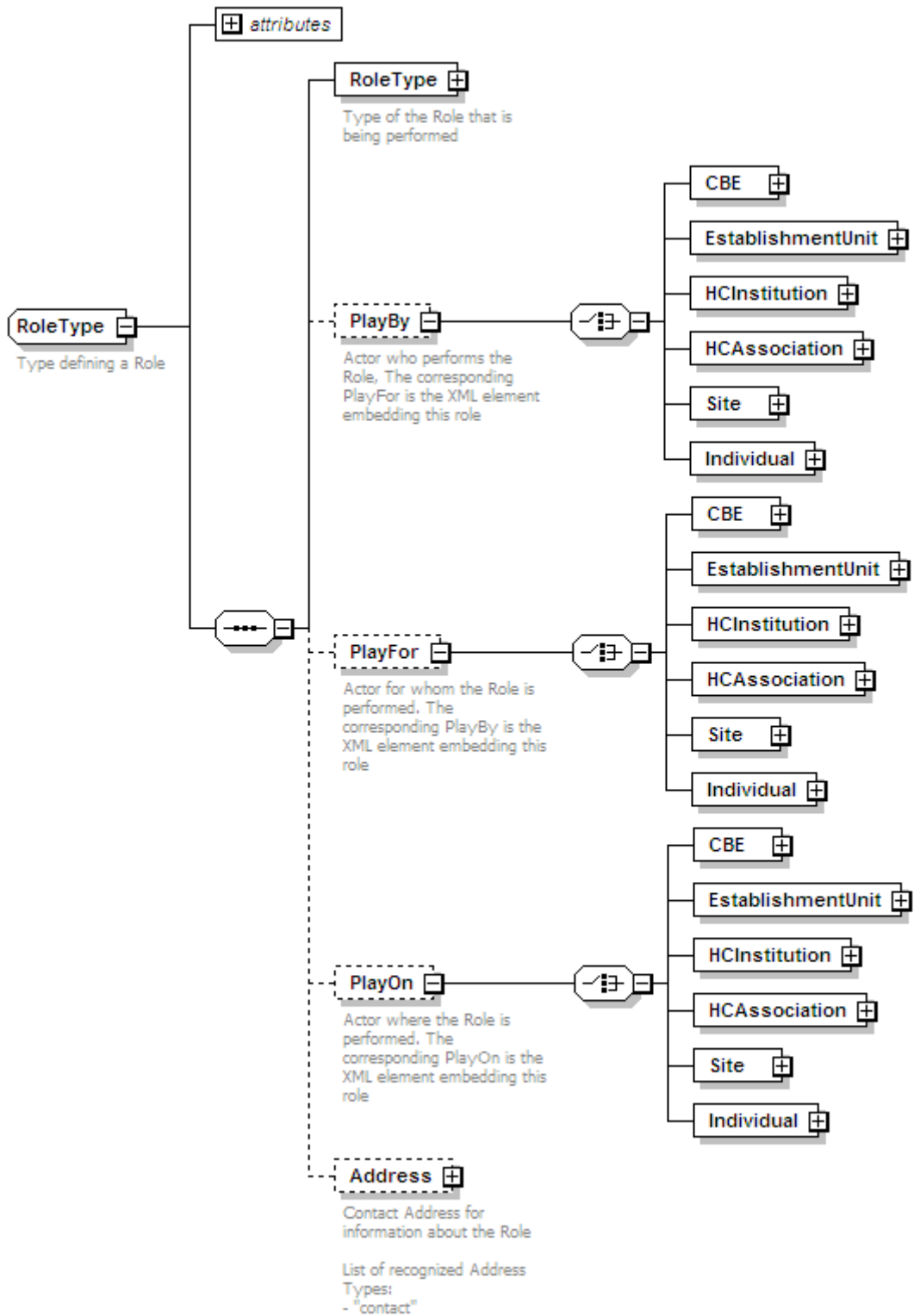

Field name	Description
RoleType – CodeWithDescriptionType (mandatory)	The type of the role that is been performed. Authentic source can be: 'WVG_VAZG', 'WVG_KG'(kind en gezin), 'WVG_JW' (jongeren en welzijn), 'WVG_VAPH', 'WVG_WS' (Welzijn en Samenleving), 'NR', CBSS', 'NIHII', 'AVIQ', 'CBE', 'FAMHP', 'BeSt', 'FPS_PH', 'NIS', 'CRAB', 'BePost', 'ISO', 'CCC_GGC' (Cocom), 'GSC_DG' (Dutch Speaking Community), 'OV_AgODi' (Onderwijs en Vorming). The type is 'role type'. See used types: CodeWithDescriptionType for more details (section 1.2.3.5).
PlayBy – CBEType, EstablishmentUnitType, HCInstitutionType, HCAssociationType, SiteType, IndividualType (mandatory if parent)	Actor who performs the role. This field is mandatory if the actor having the role does not perform the role. If the actor is already present in the CoBRHA only the identification is required. Possible actors: CBE, EstablishmentUnit, HCInstitution, Site, Individual See operations: CBEType, HCInstitutionType, HCAssociationType, IndividualType See used types: EstablishmentUnitType, SiteType for more details .
PlayFor – CBEType, EstablishmentUnitType, HCInstitutionType, HCAssociationType, SiteType, IndividualType (optional)	Actor for whom the role is performed. This field is filled out by the parent business identifier, if the playBy field is filled out. If the actor is already present in the CoBRHA than only his identification is required. Possible actors: CBE, EstablishmentUnit, HCInstitution, Site, Individual See operations: CBEType, HCInstitutionType, IndividualType See used types: EstablishmentUnitType, SiteType for more details .
PlayOn – CBEType, EstablishmentUnitType, HCInstitutionType, HCAssociationType, SiteType, IndividualType (optional)	Actor where the role is performed. This is only optional and is never filled out by the parent actor. If the actor is already present in the CoBRHA than only his identification is required. Possible actors: CBE, EstablishmentUnit, HCInstitution, Site, Individual See operations: CBEType, HCInstitutionType, IndividualType See used types: EstablishmentUnitType, SiteType for more details .
Address – AddressType (optional)	The address of the location, of the type 'contact'.

1.2.3.1.5 EstablishmentUnitType

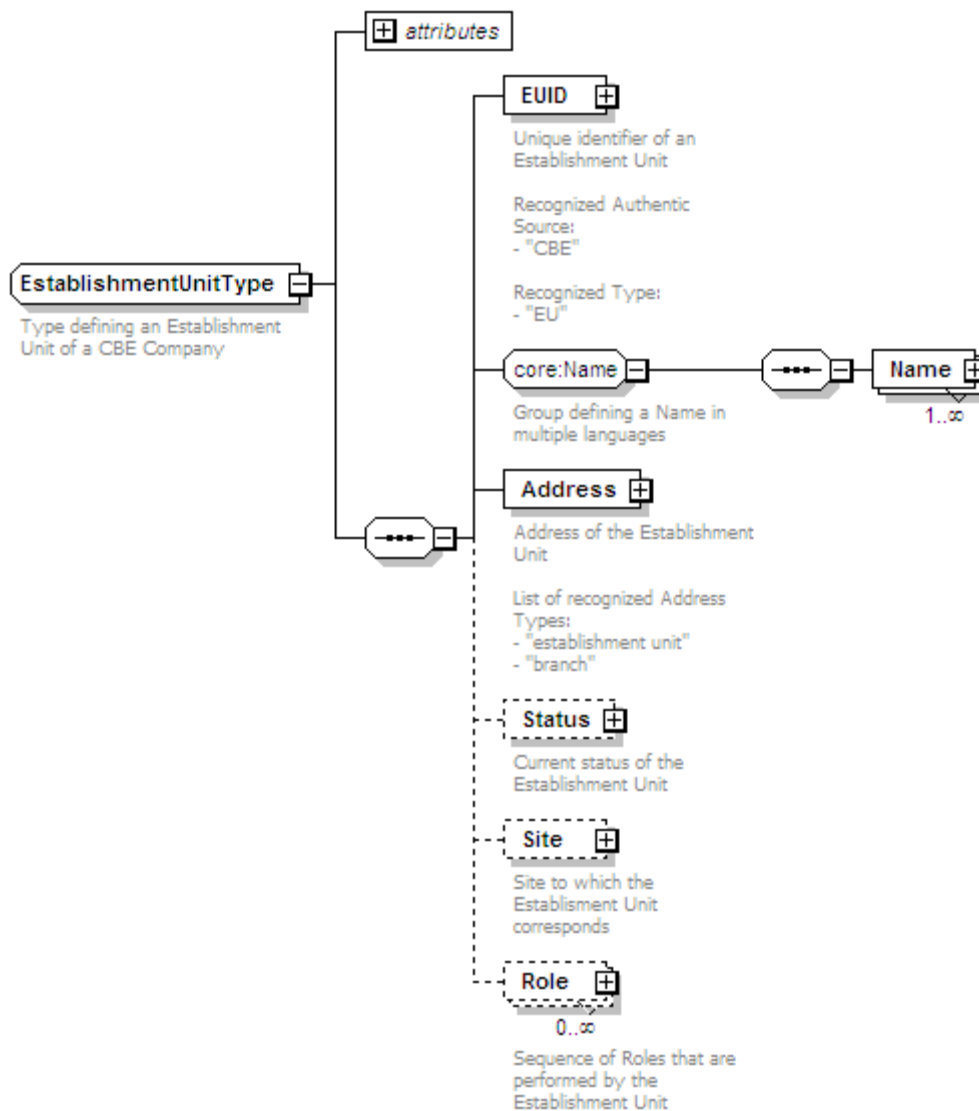

Field name	Description
EUID – IdentifierType (mandatory)	The unique identifier of an establishment unit provided by the CBE. The authentic source is thus the CBE, the type is 'EU' and the identifier is a structured string. See used types: IdentifierType for more details (section 1.2.3.6).
Site – SiteType (optional)	The site linked to the establishment unit. See used types: SiteType for more details (section 1.2.3.1.3).
Name – string (optional)	Name of the establishment unit. The value is a string of Max 2000 Char encoded in UTF-8.
Address – AddressType (optional)	The current address of the establishment unit. The type of the address can be 'establishment unit' or 'branch'. See used types: AddressType for more details (section 1.2.3.3).
Status – CodeWithDescriptionType (optional)	The current state of the establishment unit linked to the CBE enterprise (active, cancelled, stopped). The code is a string. The type is 'STA'. See used types: CodeWithDescriptionType for more details (section 1.2.3.5).

Role – RoleType (optional)	A role performed by the establishment unit. See used types: RoleType for more details (section 1.2.3.1.4).
----------------------------	--

1.2.3.1.6 NIHIIOrganizationType

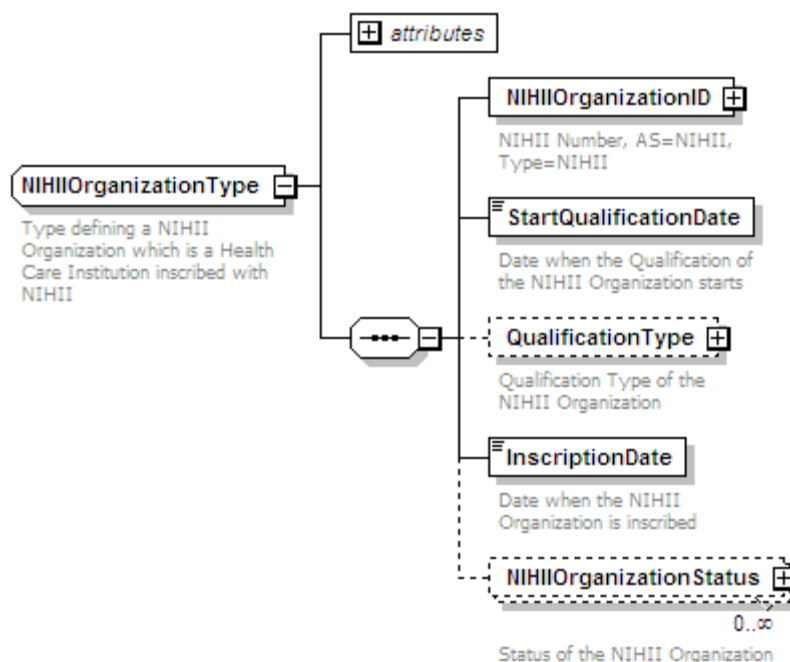

Field name	Description
NIHIIOrganizationID – IdentifierType (mandatory)	The unique identifier of NIHII organization. ('riziv nummer' in Dutch, 'numéro INAMI' in French) Authentic source is 'NIHII' and the type is 'NIHII'. See used types: IdentifierType for more details (section 1.2.3.6).
StartQualificationDate – Date (mandatory for creation)(optional for delta)	Date when the organization got the recognition from NIHII to a certain service. It is a standard Date type (YYYY-MM-DD). StartQualificationDate must be ≥ 1200-01-01
QualificationType – CodeWithDescriptionType (optional)	Code of the service type for which the recognition is given. The type is 'qualification type'. (example: emergency service, service gastro-enterologie)
InscriptionDate – Date (mandatory for creation)(optional for delta)	Date when the organization signed up as a NIHII organization. It is a standard Date type (YYYY-MM-DD). InscriptionDate must be ≥ 1800-01-01
NIHIIOrganizationStatus – CodeWithDescription + attributes (optional)	Code of the status of the NIHII organization (examples: active, inactive, and abroad). This code can have a validity start and end date. The type is 'nihiiorg status'. The InvalidElement: indication if the NIHIIOrganisationStatus is valid or not. See used types: CodeWithDescriptionType for more details (section 1.2.3.5). StartDate: date where the validity of the status starts (type: date -> YYYY-MM-DD) EndDate: date where the validity of the status ends (type: date -> YYYY-MM-DD) StartDate and EndDate must be ≥ 1200-01-01. InvalidElement: indication if the element is valid or not (type: boolean)

1.2.3.1.7 LocationType

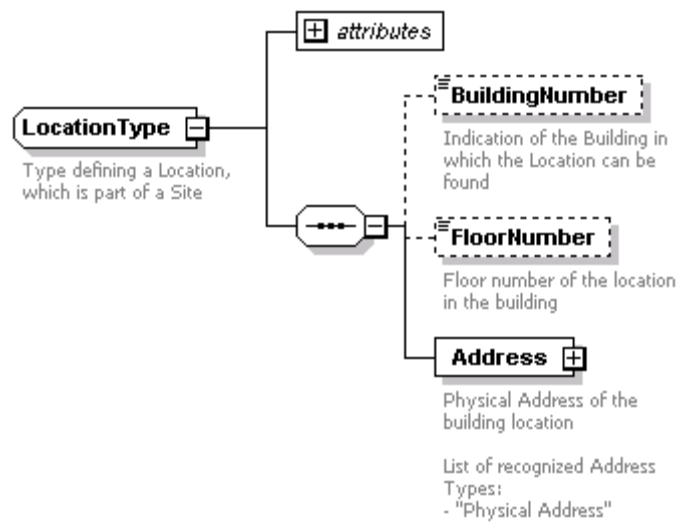

Field name	Description
BuildingNumber – string (optional)	Reference (Max Char 240 + utf-8 encoded) of the building or the location. See used types: IdentifierType for more details (section 1.2.3.6).
FloorNumber – string (optional)	Floor number (Max Char 240 + utf-8 encoded) of the location inside the building.
Address – AddressType (mandatory for creation)(optional for delta)	The address of the location; of the type 'location'.

1.2.3.1.8 HCProfessionalType

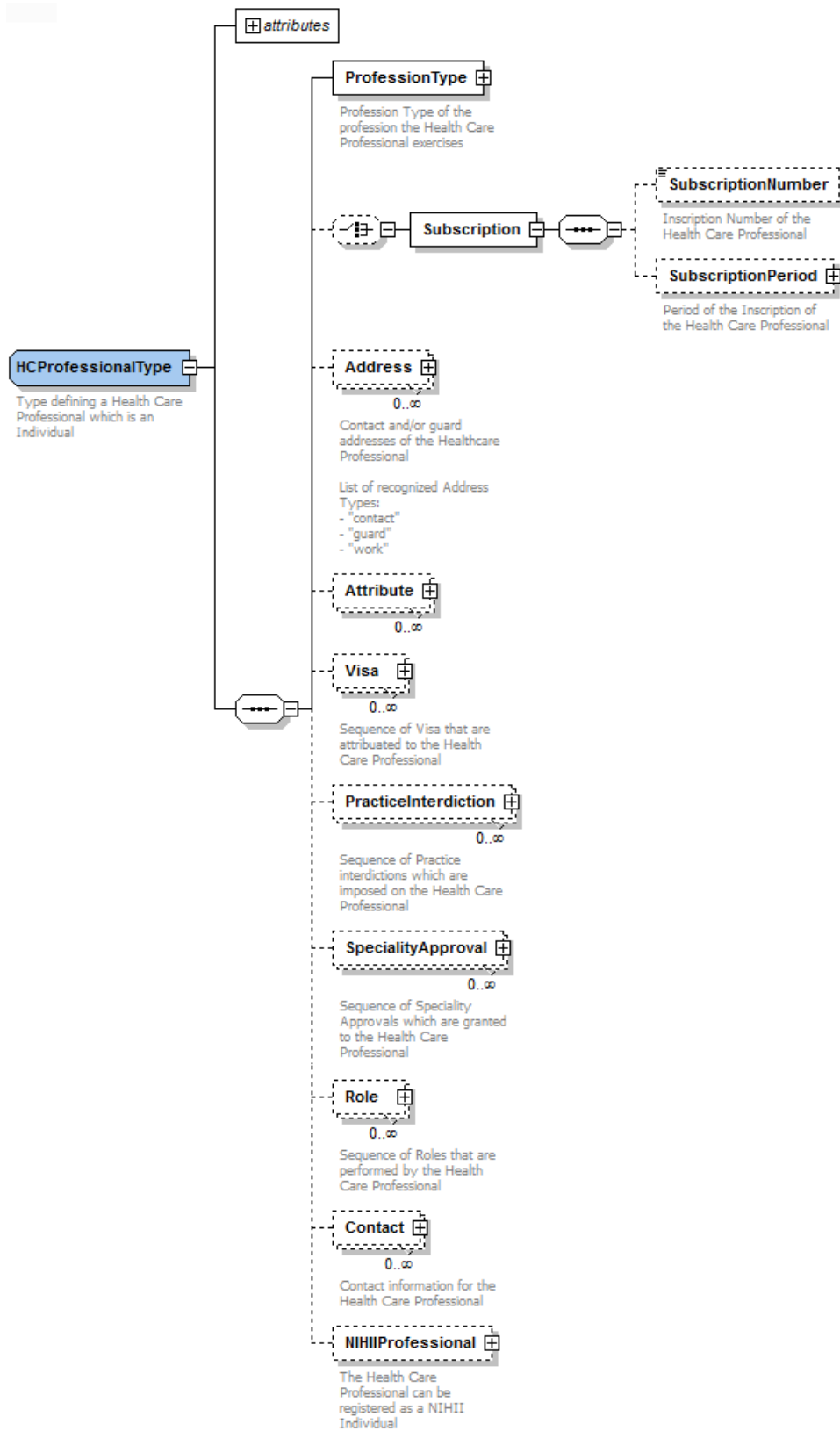

Field name	Description
ProfessionType - CodeWithDescriptionType (mandatory)	Profession code of the healthcare professional. (FPS_PH code (number or string: NIHII+number) or NIHII code (number)) The type is 'profession type'. See used types: CodeWithDescriptionType for more details (section 1.2.3.5).
Subscription/SubscriptionNumber	Subscription number given at subscription of the healthcare professional to his profession. It is mostly a five digit number
Subscription/SubscriptionPeriod (optional)	Date when the healthcare professional subscribed to the profession as described in the ProfessionType element. See used types: PeriodType for more details (section 1.2.3.8).
Address – AddressType (optional)	Current guard/contact address of the healthcare professional. The type of the address is thus 'contact', 'working'. See used types: AddressType for more details (section 1.2.3.3).
Visa – VisaType (optional)	Visa attributed to the healthcare professional. See used types: VisaType for more details (section 1.2.3.1.14).
PracticeInterdiction – PracticeInterdictionType (optional)	Start and end date of the interdiction of his professional practice and the origin of the interdiction. See used types: PracticeInterdictionType for more details (section 1.2.3.1.12).
SpecialityApproval – SpecialityApprovalType (optional)	Specialty of the healthcare professional, the approval period to exercise this specialty and optionally the training period to learn this specialty. See used types: SpecialityApprovalType for more details (section 1.2.3.1.13).
Role – RoleType (optional)	Role performed by a healthcare professional. See used types: RoleType for more details (section 1.2.3.1.4).
Contact – ContactType (optional)	Contact details for the healthcare professional. E.g.the e-mail of the healthcare professional. See used types: ContactType for more details (section 1.2.3.10).
NIHIIProfessional	Additional details provided by NIHII if the professional is recognized by NIHII for patient reimbursement. See used types: NIHIIProfessionalType for more details (section 1.2.3.1.9).

1.2.3.1.9 NIHIProfessionalType

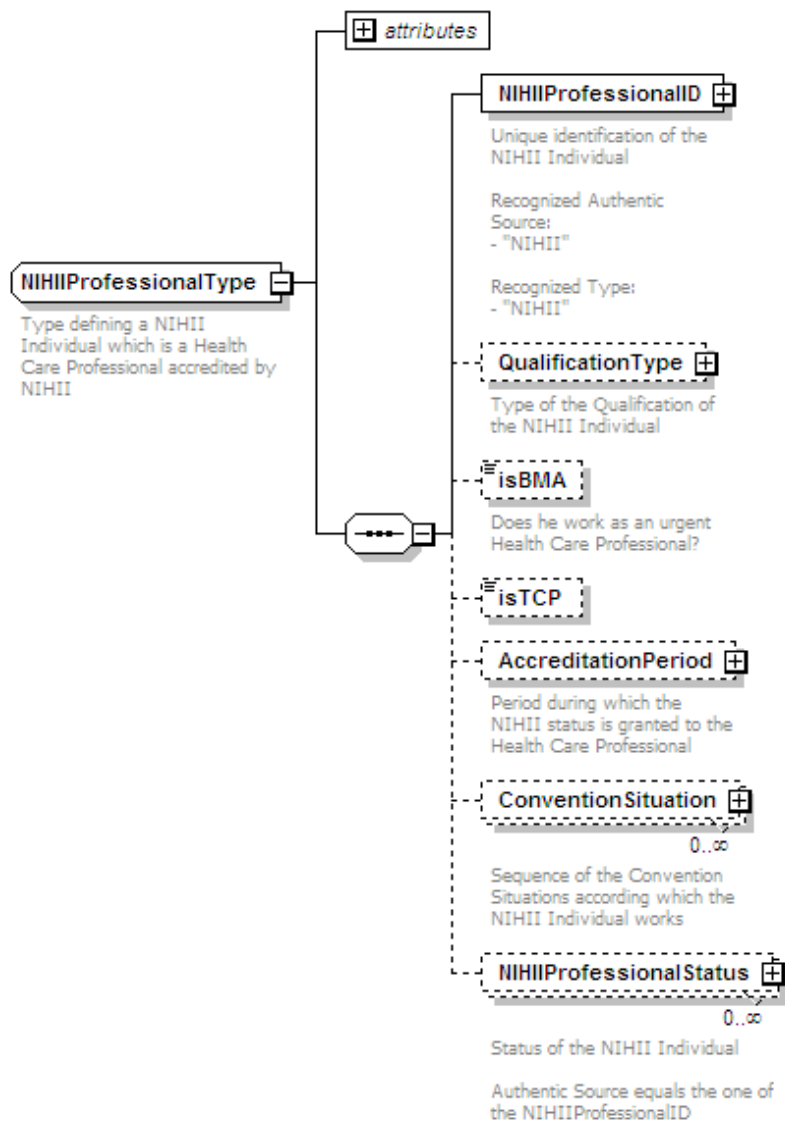

Field name	Description
NIHIProfessionalID - IdentifierType (mandatory)	NIHII identification of the healthcare professional. Possible authentic source values: 'NIHII'. Possible type: 'NIHII'. See used types: IdentifierType for more details (section 1.2.3.6).
QualificationType – CodeWithDescriptionType (optional)	Qualification code of the speciality/ies of the NIHII professional: the three last digits of the NIHII number. The type is 'qualification type'. See used types: CodeWithDescriptionType for more details (section 1.2.3.5).
isBMA – boolean (optional) (deprecated)	Flag that indicates if the healthcare professional works as an urgent healthcare professional or not.(Deprecated -> Replaced by a specific type of Attribute)
isTCP – boolean (optional) (deprecated)	Flag that indicates if the healthcare professional belongs to journey healthcare. (Deprecated -> Replaced by a specific type of Attribute)

AccreditationPeriod – PeriodType (optional)	Period the speciality/ies are accredited for to the healthcare professional by NIHII. See used types: PeriodType for more details (section 1.2.3.8).
ConventionSituation – ConventionSituationType (optional)	Convention situation of the healthcare professional. The validity period of the bounding of the professional to the convention is also given. See used types: ConventionSituationType for more details (section 1.2.3.1.10).
NIHIIProfessionalStatus – CodeWithDescription + attributes (optional)	<p>The code of the status of the NIHII Professional (example: actif, inactif, abroad,). This code can have a validity start and end date. The type is 'nihii-prof status'. The InvalidElement: indication if the NIHIIProfessionalStatus is valid or not. See used types: CodeWithDescriptionType for more details (section 1.2.3.5).</p> <p>StartDate: the date where the validity of the status starts (type: date -> YYYY-MM-DD)</p> <p>EndDate: the date where the validity of the status ends (type: date -> YYYY-MM-DD)</p> <p>StartDate and EndDate must be ≥ 1200-01-01.</p> <p>InvalidElement: indication if the element is valid or not (type: boolean)</p>

1.2.3.1.10 ConventionSituationType

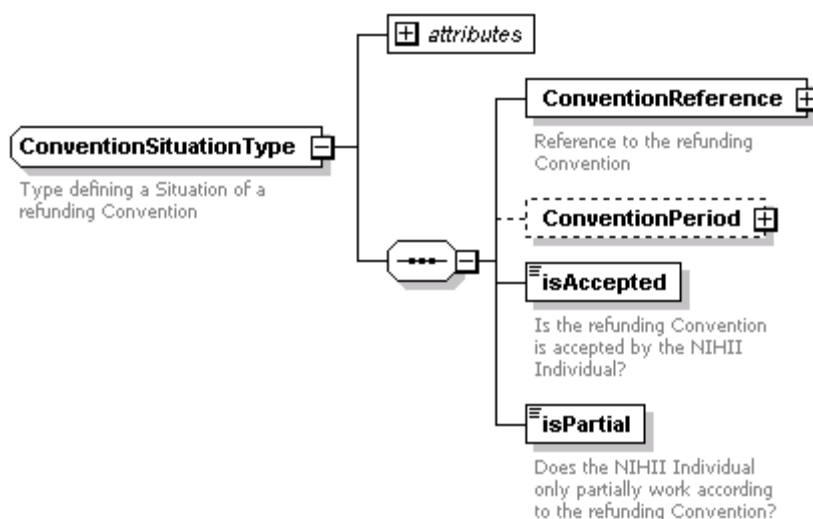

Field name	Description
ConventionReference - IdentifierType (mandatory for creation)(optional for delta)	The unique identifier of the reference to the refunding convention. Authentic source is 'NIHII' and type is 'convention number'. See used types: IdentifierType for more details (section 1.2.3.6).
ConventionPeriod – PeriodType (optional)	<p>The period within the refunding convention is globally in effect (for all healthcare professionals).</p> <p>See used types: PeriodType for more details (section 1.2.3.8).</p>
isAccepted – boolean (mandatory for creation)(optional for delta)	Flag indicating if the healthcare professional has accepted the refunding convention.

isPartial – boolean (mandatory for creation)(optional for delta)	Flag indicating if the healthcare professional completely or partially works according to the refunding convention.
--	---

1.2.3.1.11 DiplomaType

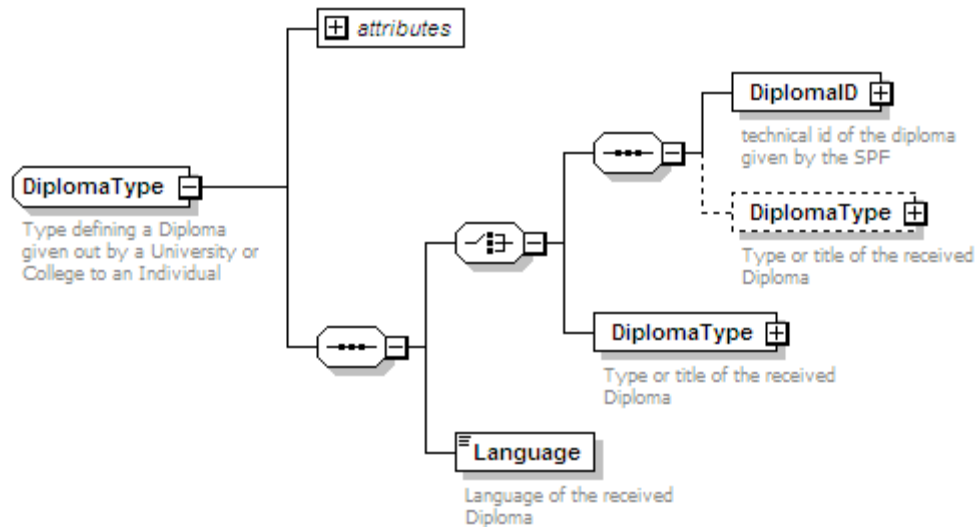

Field name	Description
DiplomaID - IdentifierType (optional)	The unique identifier of the diploma. Authentic source is 'FPS_PH' and type is 'diploma number'. See used types: IdentifierType for more details (section 1.2.3.6).
DiplomaType – CodeWithDescriptionType (mandatory for creation)(optional for delta if DiplomaID is present)	The type or title of the diploma. Authentic source is 'FPS_PH'. The type is 'diploma type'. See used types: CodeWithDescriptionType for more details (section 1.2.3.5).
Language – CodeWithDescriptionType (mandatory for creation)(optional for delta)	The preferred language of the individual in a two-character string following the standard ISO-639-1. Therefore, the Authentic Source is ISO and type code ISO-639-1. Examples: NL, FR, DE, EN, XX if unknown (lowercase or uppercase are accepted). See used types: CodeWithDescriptionType for more details (section 1.2.3.5).

1.2.3.1.12 PractiseInterdictionType

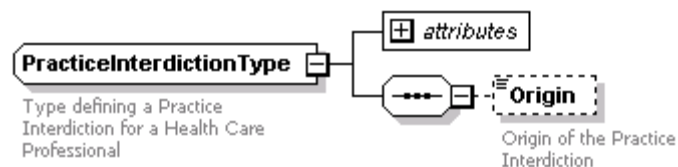

Field name	Description
Origin – CodeWithType (optional)	The origin of the practice interdiction. The authentic source is FPS_PH and the type of the code is practice interdiction origin. See used types: CodeWithType for more details (section 1.2.3.5).

1.2.3.1.13 SpecialityApprovalType

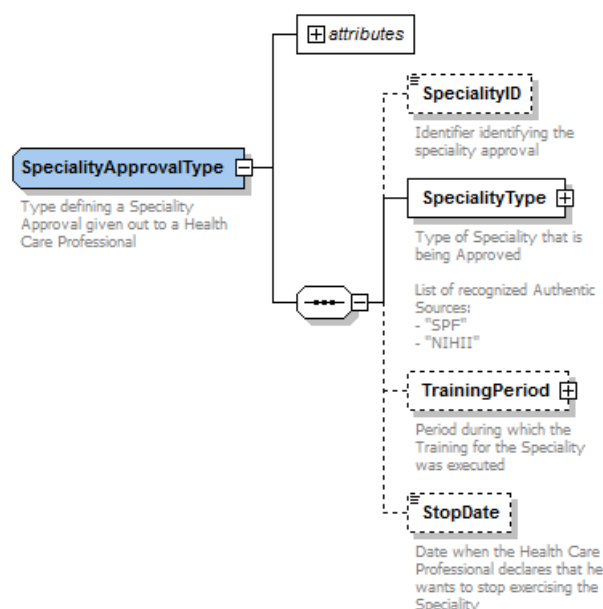

Field name	Description
SpecialityID (optional)	Identifier of speciality approval. This identifier is necessary when a professional has several equivalent speciality for different periods. Identifier must be a number between 1 and 30 digits.
SpecialityType – CodeWithType (mandatory)	The type of the speciality. The type is 'speciality type'. Possible authentic source values: 'FPS_PH', 'NIHII'. See used types: CodeWithType for more details (section 1.2.3.5).
TrainingPeriod – PeriodType (optional)	Trainings period for the speciality. See used types: PeriodType for more details (section 1.2.3.8).
StopDate – Date (optional)	The date when the healthcare professional declared ending the training of the speciality. It's a standard Date type (YYYY-MM-DD). StopDate must be ≥ 1200-01-01.

1.2.3.1.14 VisaType

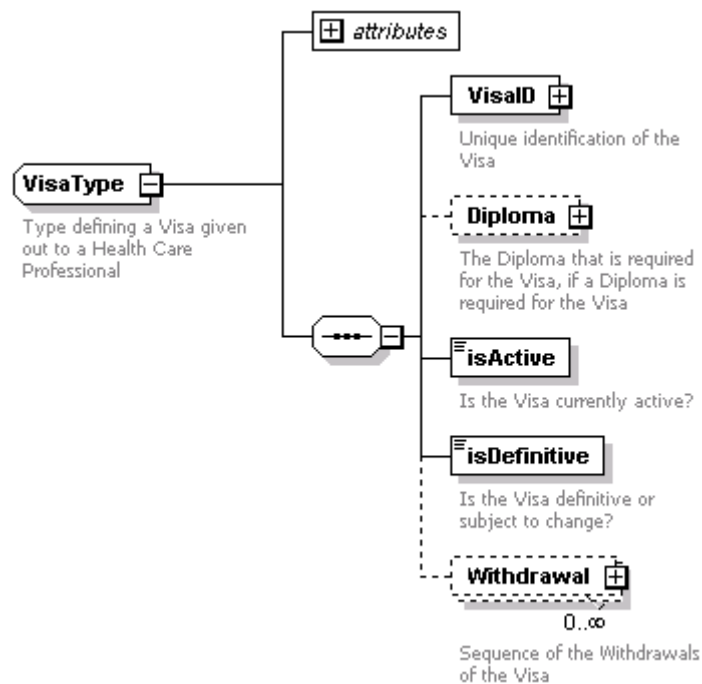

Field name	Description
VisalD – IdentifierType (mandatory)	Unique identifier of the visa. Authentic source is 'FPS_PH', type is 'visa number'. See used types: IdentifierType for more details (section 1.2.3.6).
Diploma – DiplomaType (optional)	Diploma approved by the visa. See used types: DiplomaType for more details (section 1.2.3.1.11).
isActive – boolean (mandatory for creation)(optional for delta)	Flag that defines if the visa is currently active.
isDefinitive – boolean (mandatory for creation)(optional for delta)	Flag that defines if the visa is definitive or subject to change.
Withdrawal – VisaWithdrawalType (optional)	Withdrawal (reject/made invalid) of the visa. See used types: VisaWithdrawalType for more details (section 1.2.3.1.15).

1.2.3.1.15 VisaWithdrawalType

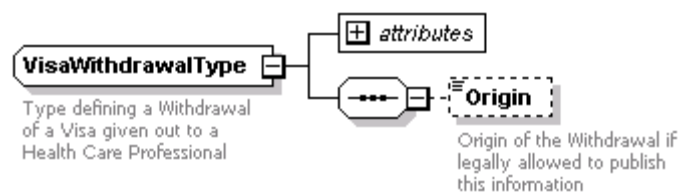

Field name	Description
Origin – CodeWithDescriptionType (mandatory)	The origin of the visa withdrawal if available. The authentic source is FPS_PH and the type of the code is visa withdrawal origin. See used types: CodeWithDescriptionType for more details (section 1.2.3.5).

1.2.3.1.16 AttributeType

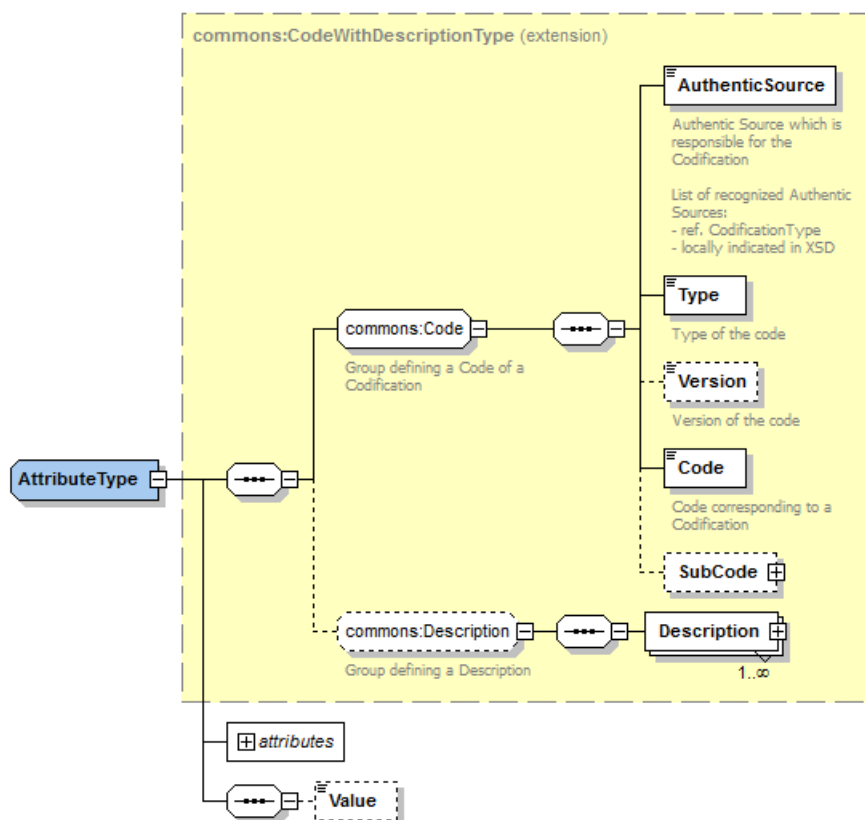

Field name	Description
AuthenticSource-codewithDescriptionType (mandatory)	The authentic source of the identifier value. Possible values: 'WVG_VAZG', 'WVG_VAPH', 'WVG_KG', 'WVG_JW', 'WVG_WS', 'FAMHP', 'NR', 'FPS_PH', 'NIHII', 'CBE', 'EHP', 'CBSS', 'SPW'. See used types: CodeWithDescriptionType for more details (section 1.2.3.5).
Type - codewithDescriptionType (mandatory)	The identifier type used by authentic source. Value is: 'attribute type'. See used types: CodeWithDescriptionType for more details (section 1.2.3.5).
Version - codewithDescriptionType (optional)	Version of the code: a string of Max 240 Char written in utf-8. See used types: CodeWithDescriptionType for more details (section 1.2.3.5).
Code - codewithDescriptionType (mandatory)	The code value is a string of Max 30 Char written in utf-8. See used types: CodeWithDescriptionType for more details (section 1.2.3.5).
SubCode-codewithDescriptionType (optional)	The code values linked to the parent code value given in the parent Value:Code tag. See used types: CodeWithDescriptionType for more details (section 1.2.3.5).

Description - codewithDescriptionType (optional)	The description of the code value. See used types: DescriptionGroup for more details (section 1.2.3.12).
Value (mandatory)	The attribute value

1.2.3.2 Technical Types

All simple types are nillable. If you give the nil (null) value to an element by setting the xsi:nil attribute on value 'true', the existing value in the database will be removed if possible. It is the only way to remove a single value from the CoBRHA DB. Identifier values of the IdentifierType can only be removed if they are not the primary business key of the ComplexType.

Identifier values with Type 'hco number' or 'site number' or 'activity number' cannot be deleted. ComplexTypes cannot be deleted: they can only be made invalid by setting the InvalidFlag on true.

1.2.3.3 AddressType

See next page.

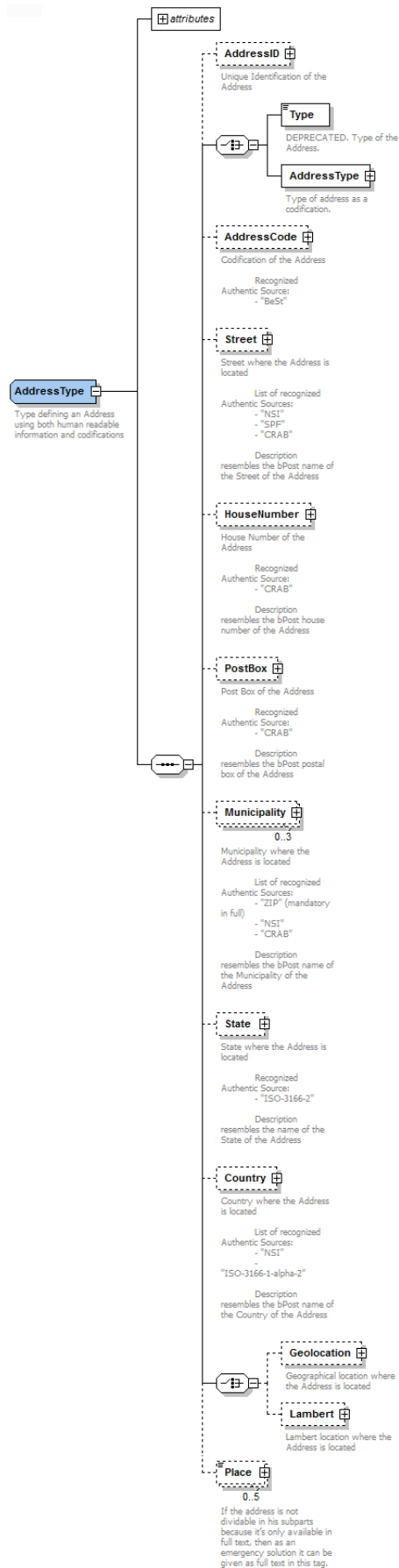

Field name	Description
AddressID (optional)	Unique identifier of the address. This id is mandatory if the type (see below) does not uniquely identify the address. Type: 'address number'. See used types: IdentifierType for more details (section 1.2.3.6).
Type (deprecated)	Type of the address. Following values are authorized: 'official', 'contact', 'guard', 'activity', 'site', 'location', 'working', 'establishment unit', 'branch', 'registered office'.
AddressType – CodeWithDescriptionType (mandatory)	Type of the address. Following values are authorized: 'official', 'contact', 'guard', 'activity', 'site', 'location', 'working', 'establishment unit', 'branch', 'registered office'. Authentic source: 'EHP'. Type is 'address type'. See used types: CodeWithDescriptionType for more details (section 1.2.3.5). <u>Example:</u> <pre><AddressType> <AuthenticSource>EHP</AuthenticSource> <Type>address type</Type> <Code>contact</Code> </AddressType></pre>
AddressCode – CodeWithDescriptionType (optional)	Address code given by authentic source 'BeSt' and type 'address'. This code identifies uniquely an address. See used types: CodeWithDescriptionType for more details (section 1.2.3.5).
Street – CodeWithDescriptionType or DescriptionGroup (optional)	When the street code is known or given by one of the following authentic sources: 'FPS_PH', 'NIS', 'CRAB', it should be sent in the code tag inside the street tag. They all use type 'street'. When the street code is not available, the exact name of the street with the language linked to it must be entered in the description group. You should give the street code OR the street name. See used types: CodeWithDescriptionType (section 1.2.3.5), DescriptionGroup for more details (section 1.2.3.12).
HouseNumber – code (CodeWithDescriptionType) or Number (optional)	If the code of the house number is known or given by the authentic source 'CRAB' and type 'house number', then it should be sent in the code tag inside the HouseNumber tag. If the code is not available than the exact number of the building must be entered in the house number tag. The post box is the bpost name of the postal box of the address. You should give the code OR the house number. See used types: CodeWithDescriptionType for more details (section 1.2.3.5).
PostBox – code (CodeWithDescriptionType) or PostBox (optional)	The post box is filled out in the post box tag if more than one post box is linked to the house number. If the CRAB code of the post box is known, then this is written in the code tag. Authentic source 'CRAB' and type 'postbox'. See used types: CodeWithDescriptionType for more details (section 1.2.3.5).
Municipality – CodeWithDescriptionType or DescriptionGroup (optional)	The zip code (example 9000 for Ghent, 2000 for Antwerp) should be sent in the code tag, the name of the municipality (Antwerpen for Dutch, Anvers for French) linked to the zip code should also be entered if available inside the code tag as description. The authentic source is 'BePost', the type is 'ZIP'. Optionally if the NIScode (code given to administration entities by the National Statistical Institute of Belgium) is known, it should be sent as a code with the authentic source 'NIS' and type 'municipality'. Optionally if the CRABcode (code given to administration entities by the AGIV) is known, it should be sent as a code with the authentic source 'CRAB' and type 'municipality'. Exceptionally, if none of the codes are available then the name of the municipality linked to a language can be given in the DescriptionGroup. See used types: CodeWithDescriptionType (section 5.6.4.3), DescriptionGroup for more details (section 1.2.3.12).

State – CodeWithDescriptionType or DescriptionGroup (optional)	The state in which the building is located. When the code given by authentic source 'ISO-3166-2' (WA for Washington, VA for Virginia) is available, it should be sent in the code tag with authentic source 'ISO' and type 'ISO-3166-2'. When the code is not available the name of the state linked to his language (Washington, Texas, California, ...) should be given in the DescriptionGroup. You should give the state code OR the state name. See used types: CodeWithDescriptionType (section 1.2.3.5), DescriptionGroup for more details (section 1.2.3.12).
Country – CodeWithDescriptionType or DescriptionGroup (optional)	Country in which the building is located. If the code given by one of the following authentic sources: 'NIS' and type 'country' or ISO and type 'ISO-3166-1-alpha-2', the code must be entered in the code tag of the country tag together with the authentic source name. If this code is not available, the country name with the language of that name should be given in the description group inside the country tag. See used types: CodeWithDescriptionType (section 1.2.3.5), DescriptionGroup for more details (section 1.2.3.12).
GeoLocation – Latitude and Longitude decimal numbers (optional)	GPS location of the address in decimal degrees. If available, the latitude decimal degree and the longitude decimal degree are mandatory.
Lambert – X and Y decimal numbers (optional)	The Lambert position (more accurate numbers than GPS provided by CRAB) of the address. If available, the X and Y numbers are mandatory.
Place – LocalizedString (optional)	If the address is not dividable in his subparts because it is only available in full text, then you can write it in full in this tag (Max Char 240 + utf-8 encoded) as an emergency solution. See used types: LocalizedString for more details (section 1.2.3.7).

1.2.3.4 BankAccountType

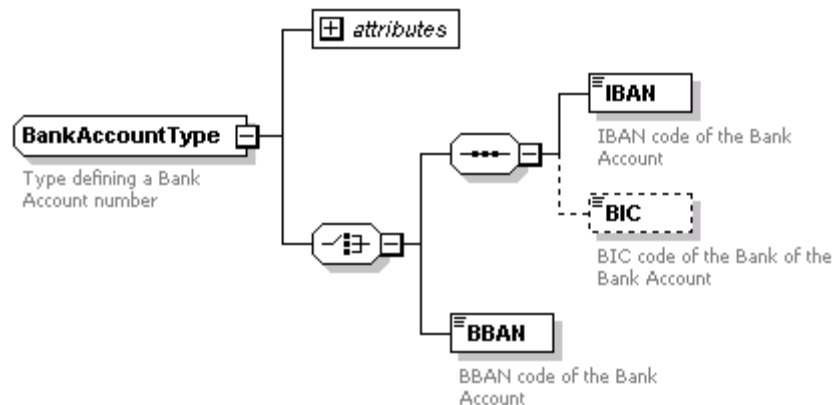

Field name	Description
IBAN – string (mandatory for creation)(optional for delta)	When you choose IBAN/BIC, the IBAN code of the Bank Account is mandatory. It has the following structure, regex: [a-zA-Z]{2}[0-9]{2}[a-zA-Z0-9]{4}[0-9]{7}([a-zA-Z0-9]{0,16})
BIC – string (optional if chosen IBAN)	The BIC code of the bank is optional if chosen for IBAN. It has the following structure, regex: ([a-zA-Z]{4}[a-zA-Z]{2}[a-zA-Z0-9]{2}([a-zA-Z0-9]{3})?)
BBAN – string (mandatory for)	When you choose for BBAN, the BBAN code of the bank account is mandatory. It has the following structure, regex: [0-9]{12}

creation)(optional for delta)	
-------------------------------	--

1.2.3.5 CodeWithDescriptionType

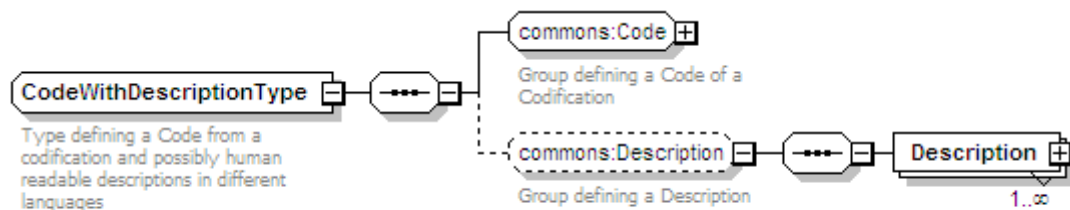

Generated by XMLSpy

www.altova.com

Field name	Description
Code – CodeGroup (mandatory)	The code value is a string of Max 30 Char written in utf-8 with additional elements like AuthenticSource, Type and Version. See used types: CodeGroup for more details (section 1.2.3.9).
Description – DescriptionGroup (optional)	A description of the code value to explain what the value represents in a specific language. It is optional. See used types: DescriptionGroup for more details (section 1.2.3.12).

1.2.3.6 IdentifierType

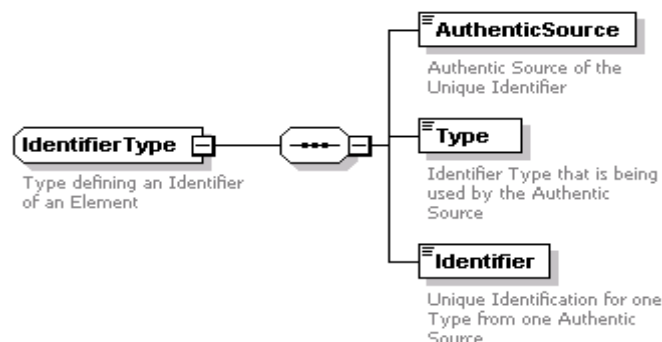

Field name	Description
AuthenticSource – string (mandatory)	Authentic source of the identifier value. Possible values: WVG_VAZG', 'WVG_KG'(kind en gezin), 'WVG_JW'(jongeren en welzijn), 'WVG_VAPH', 'WVG_WS' (Welzijn en Samenleving), 'NR', CBSS', 'NIHII', 'AVIQ', 'CBE', 'FAMHP', 'BeSt', 'FPS_PH', 'NIS', 'CRAB', 'BePost', 'ISO', 'CCC_GGC' (Cocom), 'GSC_DG' (Dutch Speaking Community), 'OV_AgODi' (Onderwijs en Vorming), 'EHP'.
Type – string (mandatory)	Identifier type used by an authentic source. Possible values: CBE, eu, approval number, site number (for all siteID's that are not of type GKB), file number, hco number, GKB (deprecated), NIHII, NISS, NISS bis, profession, convention number, diploma number, visa number, SpecialityID.
Identifier – string (mandatory)	The unique identifier value (Max Char 2000 + utf-8).

1.2.3.7 LocalizedString

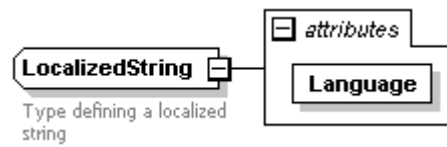

Field name	Description
LocalizedString – string (mandatory)	Text of Max 2000 Char in utf-8 with a language attribute. The language attribute is mandatory and composed of two uppercase Char to identify a language (NL: Dutch, FR: French, DE: German, EN: English, XX: Other) Lowercase or uppercase are accepted.

1.2.3.8 PeriodType

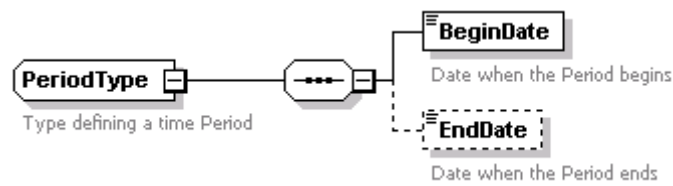

Field name	Description
BeginDate – date (mandatory)	Begin date of the period. It is a standard Date type (YYYY-MM-DD). BeginDate must be ≥ 1200-01-01
EndDate – date (optional)	End date of the period. It is a standard Date type (YYYY-MM-DD). EndDate must be ≥ 1200-01-01

1.2.3.9 CodeGroup

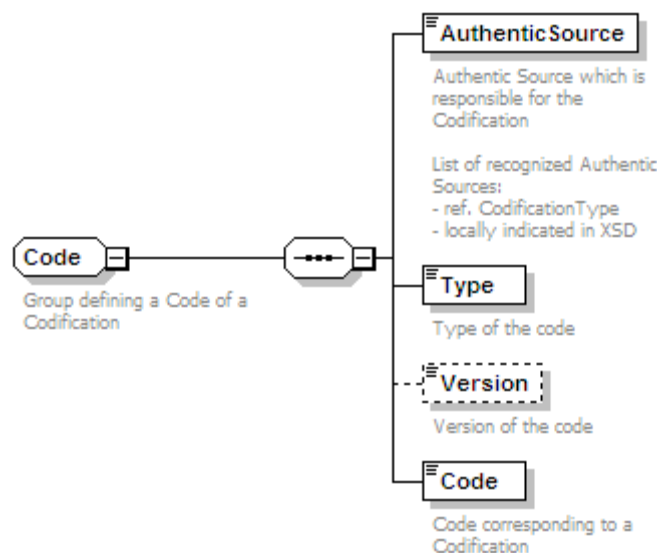

Field name	Description
AuthenticSource – string (mandatory)	Authentic source of the code value. Possible values: 'WVG_VAZG', 'WVG_KG'(kind en gezin), 'WVG_JW'(jongeren en welzijn), 'WVG_VAPH', 'WVG_WS' (Welzijn en Samenleving), 'NR', CBSS', 'NIHII', 'AVIQ', 'CBE', 'FAMHP', 'BeSt', 'FPS_PH', 'NIS', 'CRAB', 'BePost', 'ISO', 'CCC_GGC' (Cocom), 'GSC_DG' (Dutch Speaking Community), 'OV_AgODi' (Onderwijs en Vorming), 'EHP'.
Type – string (mandatory)	Type of the code. It is a string of Max 240 Char written in utf-8. Example: for the profession code is the type 'Profession'. The zip code has as type 'ZIP'.
Version – String (optional)	Version of the code. It is a string of Max 240 Char written in utf-8.
Code – string (mandatory)	Code value is a string of Max 30 Char written in utf-8.

1.2.3.10 ContactType

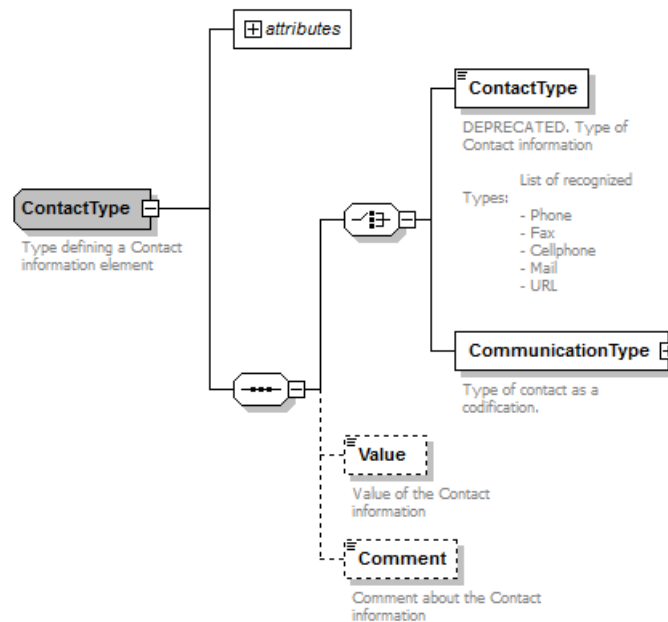

Field name	Description
ContactType (deprecated)	Type of the contact information. Recognized types: Phone, Fax, Cell phone, Mail, URL.

CommunicationType	Type of the contact details information. Accepted values for types: 'Phone', 'Phone2', 'Phone3', 'Fax', 'Fax2', 'Fax3', 'Cellphone', 'Cellphone2', 'Cellphone3', 'Mail', 'Mail2', 'Mail3', 'URL', 'URL2', 'URL3'. Authentic source: 'EHP'. Type is 'contact type'. See used types: CodeWithDescriptionType for more details (section 1.2.3.5). Example: <pre><Contact InvalidElement="0"> <CommunicationType> <AuthenticSource>EHP</AuthenticSource> <Type>contact type</Type> <Code>Fax</Code> </CommunicationType> </Contact></pre>
Value (mandatory for creation)(optional for delta)	Value linked to the contact type. For example, the value linked to a cell phone contact can be 0478625489. It is a string of Max 2000 Char written in utf-8.
Comment – string (optional)	Comment about the contact details information. It is a string of Max 2000 Char written in utf-8.

1.2.3.11 NameGroup

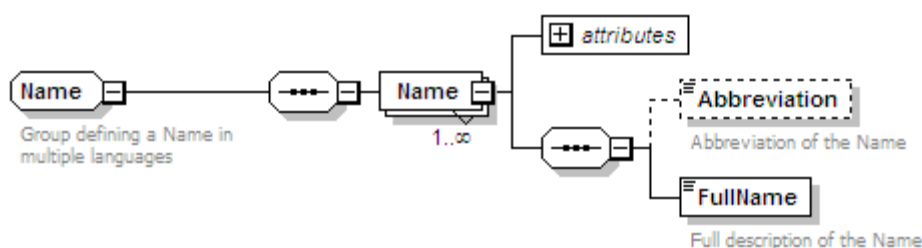

Field name	Description
Language – string (mandatory)	Language attribute; mandatory and composed of two uppercase Char to identify a language (NL: Dutch, FR: French, DE: German, EN: English, XX: Other). Lowercase or uppercase are accepted.
Abbreviation – string (optional)	Abbreviation of the name (Max 240 Char + utf-8) in a specific language.
FullName – string (mandatory)	Value of the name (Max 2000 Char + utf-8).

1.2.3.12 DescriptionGroup

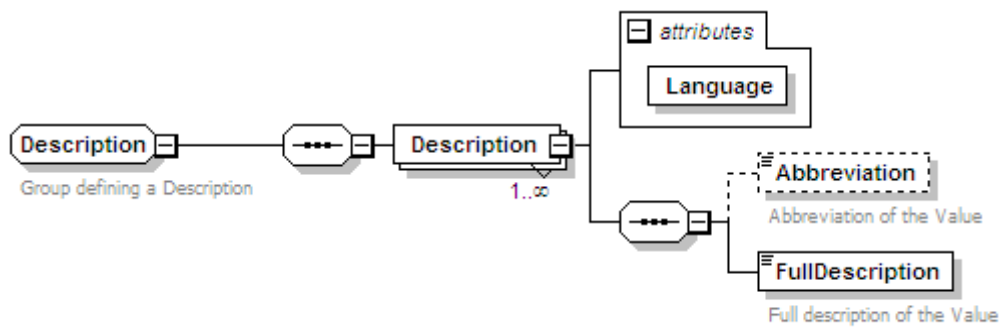

Field name	Description
Language – string (mandatory)	Language attribute, mandatory and composed of two uppercase Char to identify a language (NL: Dutch, FR: French, DE: German, EN: English, XX: Other).
Abbreviation – string (optional)	Abbreviation of the name (Max 240 Char + utf-8) in a specific language.
FullDescription– string (mandatory)	Value of the description (Max 2000 Char + utf-8).

1.3 Request Report (ehealth-cobrha-schema-report.xsd)

The request execution report xml is the same for publication and for consultation by file exchange or synchronous web service. The only difference is that only one operation will appear in the request report for synchronous web service with no reference to an input file and probably multiple operations organized by file for the file exchange. See below for the structure of the requestReport xml.

1.3.1 Request Report Structure

1.3.1.1 RequestReport Root

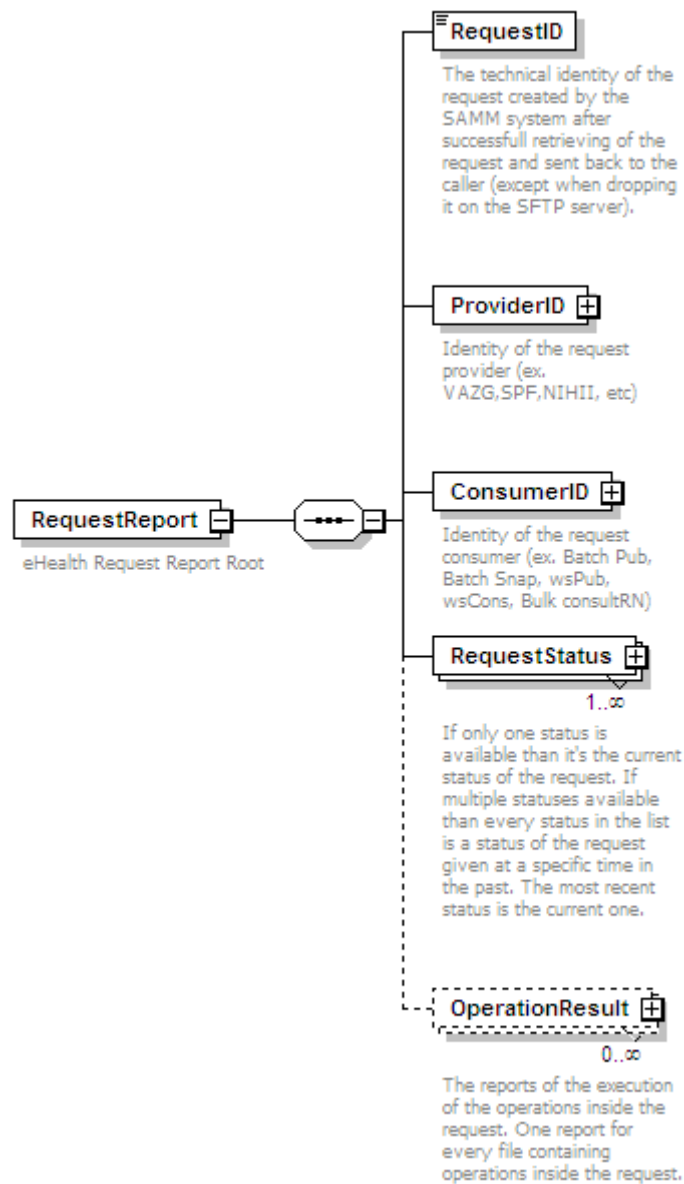

Field name	Description
RequestID – number (mandatory)	The technical identity of the request created by the COBRHA system retrieving the request.
ProviderID – string (mandatory)	Unique identifier of the request provider (ex. 'WVG – VAZG', 'FPS_PH,NIHII', etc). Authentic source: 'WVG – VAZG', 'FPS_PH,NIHII', etc. Type: 'AuthenticSource'. See used types: IdentifierType for more details (section 1.3.2.1).–
ConsumerID – string (mandatory)	Unique identifier of the request consumer Authentic Source: eHealth, Type: application (ex. COBRHA web service, COBRHA File Exchange). See used types: IdentifierType for more details (section 1.3.2.1).
RequestStatus – StatusType (mandatory)	If only one status is available than it is the status of the request. If multiple statuses available than every status in the list is a status of the request given at a specific time in the past. The most recent status is the current one. See used types: StatusType for more details.
OperationResult – OperationResultType (optional)	Report on the execution of the operations inside the request. For synchronous web service, you will have one report without reference to a file and with just one operation in it. For file exchange communication, you have one report for every file linked to the request and containing operations. See used types: OperationResultType for more details.

1.3.2 Used Types

1.3.2.1 IdentifierType

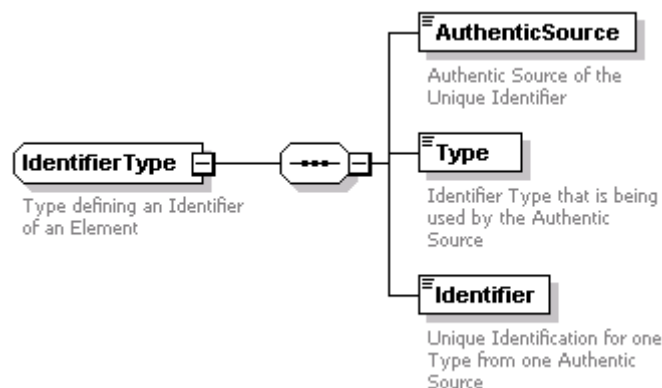

Field name	Description
AuthenticSource – string (mandatory)	Authentic source of the identifier value. Possible values: 'WVG_VAZG', 'WVG_KG' (kind en gezin), 'WVG_JW' (jongeren en welzijn), 'WVG_VAPH', 'WVG_WS' (Welzijn en Samenleving)'NR', 'CBSS', 'NIHII', 'AVIQ', 'CBE', 'FAMHP', 'BeSt', 'FPS_PH', 'NIS', 'CRAB', 'BePost', 'ISO' 'CCC_GGC' (Cocom), 'GSC_DG' (Dutch Speaking Community), 'OV_AgODi' (Onderwijs en Vorming), 'EHP'.
Type – string (mandatory)	Identifier type that is used. Possible values: 'request number', 'application number', 'operation number', 'CBE', 'eu', 'site number (for all siteID's that are not of type GKB), 'file number', 'hco number', 'GKB (deprecated)', 'NIHII', 'NISS', 'NISS bis'.
Identifier – string (mandatory)	Unique identifier value (Max Char 2000 + utf-8).

1.3.2.2 RequestStatusType

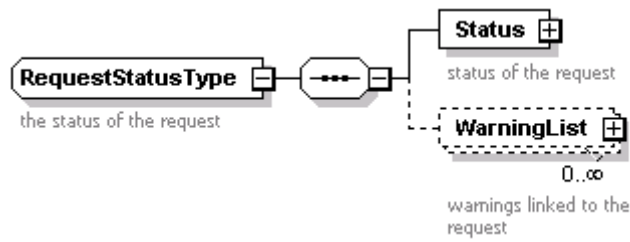

Field name	Description
Status – StatusType (mandatory)	Status of the request given by the system. See used types: StatusType for more details (see section 1.3.2.3).
WarningList – StatusType (optional)	Warning status of the request given by the system. See used types: StatusType for more details (see section 1.3.2.3).

1.3.2.3 StatusType

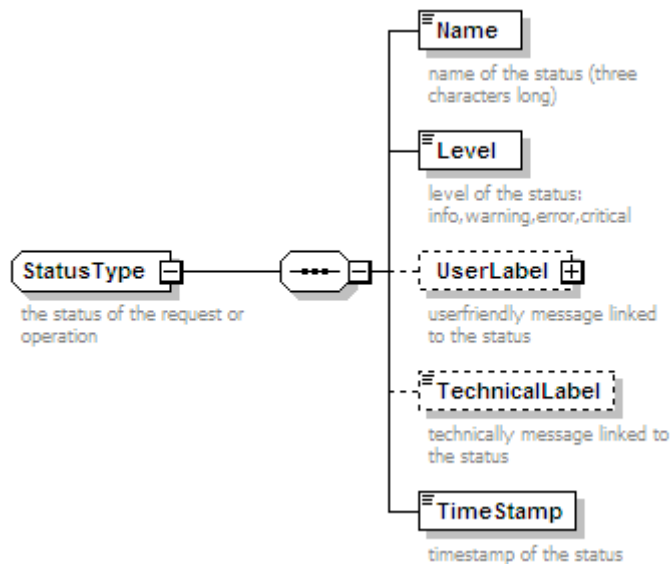

Field name	Description
Name (mandatory)	Value of the status. This is a three-character code. See chapter 8 for more explanation about the statuses.
Level – string (mandatory)	The level of the status. Four possible values: details, warning, error, critical.
UserLabel – LabelType (optional)	User-friendly message linked to the status in English. See used types: LabelType for more details. For one status, the UserLabel will not be shown to prevent an important number of redundant data.
TechnicalLabel – string (optional)	Technical message linked to the status in English (Max 2000 Char + utf-8). Not visible for all partners.
TimeStamp – dateTime (mandatory)	Timestamp of the status; a dateTime simpletype. Example: 2010-03-22T00:33:25Z.

1.3.2.4 OperationResultType

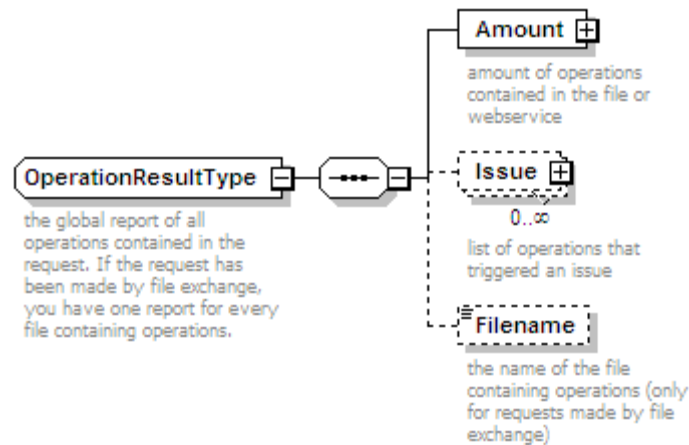

Field name	Description
Amount (mandatory)	Amount of operations split in 'executed/executed with warnings/not executed/failed' amount contained in the file identified by the filename. If no filename present than the amount will be just one because a synchronous web service call may only sent one publish operation.
Issue – OperationType (optional)	Operation that raised a certain logging level that is higher or equal to the issue level linked to the request. See used type: OperationType for more details (see section 1.3.2.6)
Filename – string (optional)	The filename where the operations in this report originates. This tag is only available when the request was made by file exchange.

1.3.2.5 OperationAmountType

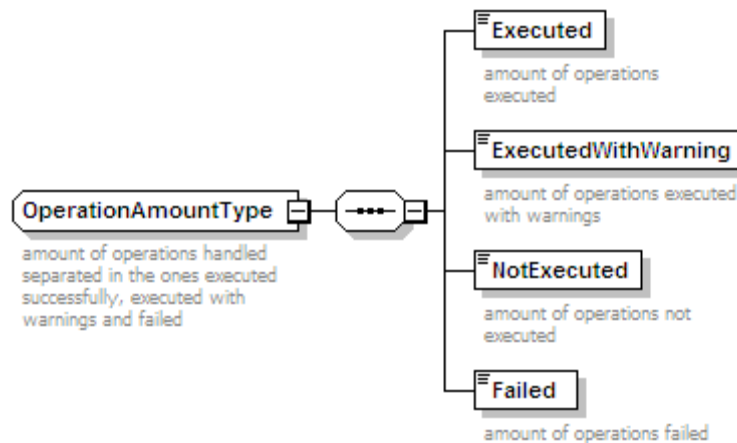

Field-name	Description
Executed – number (mandatory)	Amount of operations executed successfully without warnings.
ExecutedWithWarning – number (mandatory)	Amount of operations executed successfully but they raised warnings.
NotExecuted – number (mandatory)	Amount of operations not executed because the data was already available in the CoBRHA DB.

Failed – number (mandatory)	Amount of operations failed.
-----------------------------	------------------------------

1.3.2.6 OperationType

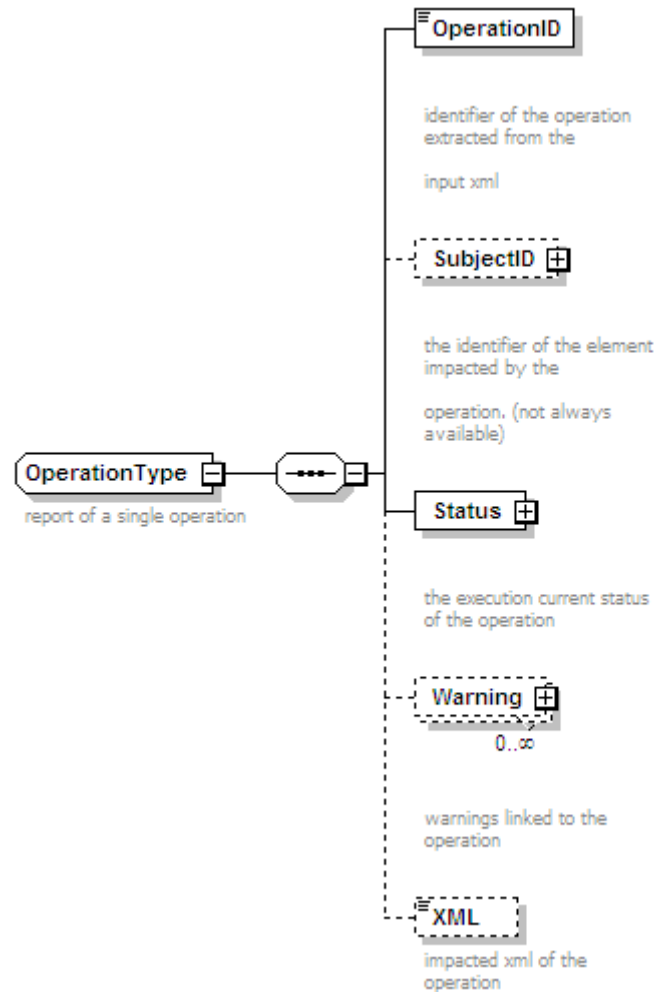

Field name	Description
OperationID – IdentifierType (mandatory)	The unique identifier of the operation inside the file or the call extracted from the input xml. See IdentifierType for more details (section 1.3.2.1).
SubjectID – IdentifierType (optional)	The identifier of the element impacted by the operation if available. See IdentifierType for more details (section 1.3.2.1).
Status – StatusType (mandatory)	The current status of the operation. See used type: StatusType for more details (section 1.3.2.3).
Warning – StatusType + XML tag (see below) (optional)	A warning status linked to the operation + the xml linked to the warning. See used type: StatusType for more details (section 1.3.2.3).
XML – Any (optional)	The input xml of the operation if the operation failed. A filtered xml with only the values that modified something in the CoBRHA if the operation was executed successfully (with or without warnings).

1.3.2.7 LabelType

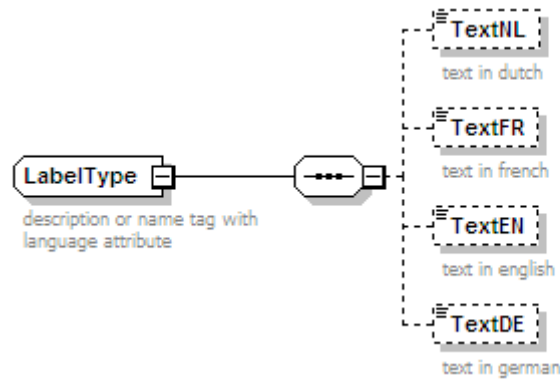

Field-name	Description
TextNL – string (optional)	Label text in Dutch (Max 240 Char).
TextFR – string (optional)	Label text in French (Max 240 Char).
TextEN – string (optional)	Label text in English (Max 240 Char). Normally this is be the only text available.
TextDE – string (optional)	Label text in Deutsch (Max 240 Char).

1.4 Meta Data XML File

The meta data xml file is a file inside the zip-file, sent for publication on the CoBRHA by file exchange.

1.4.1 Meta Data file XML Structure (ehealth-zipmetadata.xsd)

1.4.1.1 ZipMetaDataFile Root

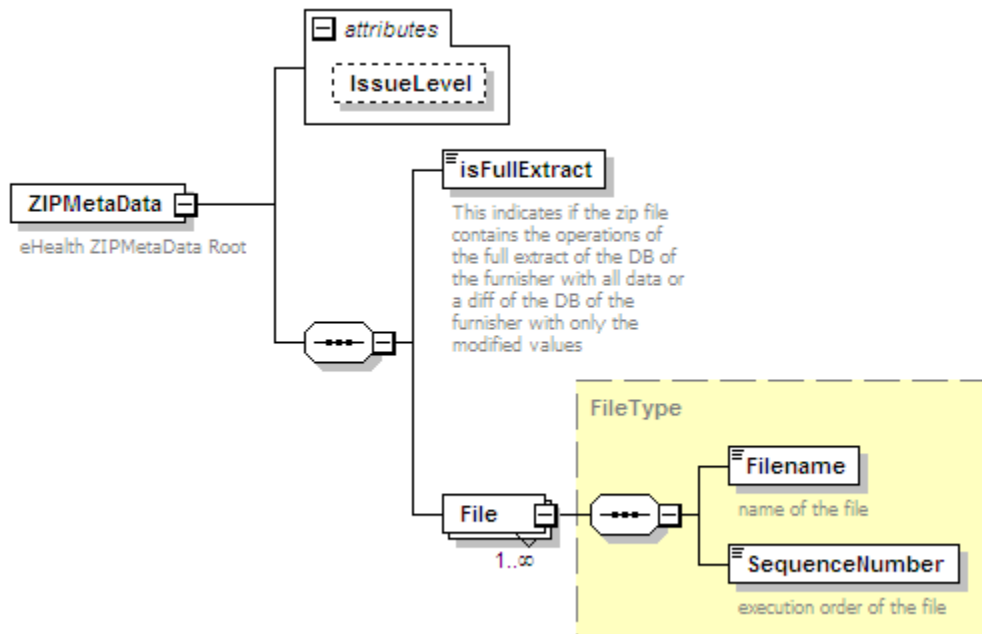

Field name	Description
IssueLevel (attribute) – string enumeration (optional)	The IssueLevel that should be shown in the report. Possible values are debug, details , warning, error and critical. When the Issuelevel is set on debug, this means that by default all details about all operation executions will be sent in the Issue elements of the OperationResult element of the report. When the Issuelevel is set on warning, only operations that trigger warnings, errors and/or criticals are present in the Issue elements of the report. When there is no IssueLevel specified, the issueLevel depends on the environment.
isFullExtract – boolean (mandatory)	This indicates if the zip file contains the operations of a full extract of the DB of the furnisher with all data or a delta of the DB of the furnisher with–only modified values.
File – FileType (mandatory)	A publication file inside the zip file containing two mandatory fields: Filename: the name of the file SequenceNumber: the execution order number of the file starting with 1. (1 -> first to be executed, 2 -> second to be executed and so on)

1.5 Synchronous Publish Operation Web Service

This web service allows authorized data furnishers to feed in real time the common registry by providing in input a correct XML element corresponding either to one Individual or one HCAssociation or one HCIInstitution or one Codification or one CBEcompany with all the data relative to it. In output the web service will return a report containing eventual publication warnings or errors.

1.5.1 PublishRequest XML Structure (ehealth-cobrha-publication-schema-protocol.xsd)

1.5.1.1 PublishRequest Root

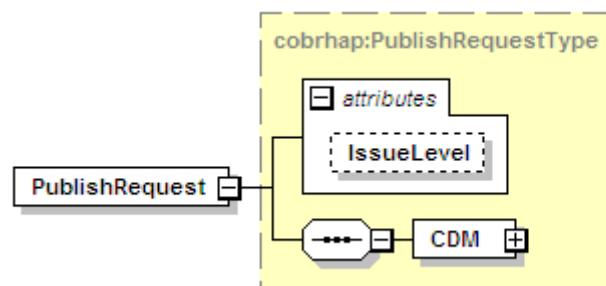

Field name	Description
IssueLevel (attribute) – string enumeration (optional)	The IssueLevel that should be shown in the report. Possible values are debug, details , warning, error and critical. When the Issuelevel is set to debug, this means that by default all details about all operation executions will be sent in the Issue elements of the OperationResult element of the report. When the Issuelevel is set on warning, only operations that trigger warnings, errors and/or criticals are present in the Issue elements of the report. When there is no IssueLevel specified, the issueLevel depends on the environment.
CDM – CDMType (mandatory)	The CDM follows totally the CDM root of the ehealth-cobrha-schema-core.xsd. Only one publish operation linked to the CDM root is permitted to avoid timeout issues.

1.5.2 PublishResponse XML Structure (ehealth-cobrha-publication-schema-protocol.xsd)

1.5.2.1 PublishResponse Root

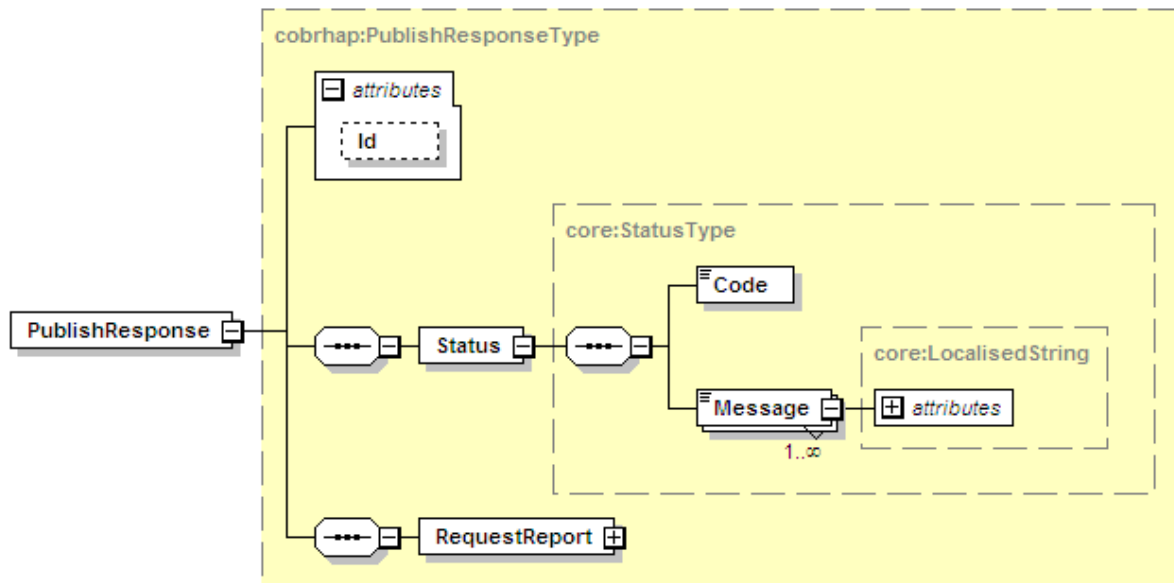

Field name	Description
Id (attribute) – string (optional)	The unique generic identifier given by our enterprise service bus for all web service calls inside eHealth.
Status – StatusType (mandatory)	The status of the publish request. See chapter 8 of the status codes. The messages are localized (french/english/dutch) and give the description of the status code.
RequestReport – RequestReportType (mandatory)	The complete report of the execution of the publish operation.